

Diabetes Mellitus

Methods and Protocols

Edited by

Sabire Özcan



Humana Press

Isolation of Islets of Langerhans from Rodent Pancreas

Colleen B. Kelly, Libby A. Blair, John A. Corbett, and Anna L. Scarim

1. Introduction

Pancreatic β -cells, responsible for the synthesis and secretion of insulin in response to a glucose challenge, are located in the islets of Langerhans. Islets are comprised of a heterogeneous population of endocrine cells, including insulin-producing β -cells (approx. 65–70%), glucagon-secreting α -cells (20–25%), somatostatin-secreting δ -cells, and polypeptide (PP)-secreting cells. Much of the cellular and biochemical information concerning the mechanisms by which glucose stimulates insulin secretion by pancreatic β -cells has been obtained in studies using islets isolated from rodents (**1**). Rat islets provide an ideal source of insulin-producing tissue to study pancreatic β -cell function as insulin secretion by rat islets closely parallels insulin secretion by human islets and it is possible to obtain a large number of islets (300–600) from a single rat pancreas. With the widespread development of transgenic and gene knockout models, mouse islets represent an ideal system to study specific changes in gene expression on β -cell function. In this chapter, the methods that we routinely use to isolate islets from rat and mouse pancreata are described.

2. Materials

Any differences between mouse and rat procedures will be specified below.

2.1. Equipment

1. Wrist-action shaker with extension arm.

2. Three-prong adjustable clamps (two) to be attached to the extension arm.
3. Adjustable temperature water bath.
4. Laminar-flow hood.
5. Dissecting microscope with overhead light source.
6. Large tabletop centrifuge with swinging bucket rotor capable of attaining 805g.
7. Vortex.

2.2. Media and Reagents

All media are from Gibco-BRL–Life Technologies, Inc. (Grand Island, NY) unless stated.

1. Hanks' Balanced Salt Solution (HBSS): 450 mL sterile water, 50 mL 10X HBSS without sodium bicarbonate and phenol red, 2.5 mL penicillin/streptomycin solution (10,000 U/mL/per10,000 µg/mL solution), 1.5 mL sodium bicarbonate solution (7.5% [w/v] solution), 1 mL phenol red solution (0.5% in DPBS; Sigma, St. Louis, MO).
2. CMRL-1066 complete media (cCMRL-1066): To prepare 500 mL of cCMRL-1066, combine 440 mL of 1X CMRL-1066 without L-glutamine, 50 mL heat-inactivated fetal bovine serum (Hyclone, Logan, UT), 5 mL penicillin/streptomycin solution, and 5 mL L-glutamine (20 mM solution).
3. HEPES HBSS: Same protocol as for HBSS with the addition of 12 mL of 1 M HEPES solution (pH 7.35).
4. Collagenase: Clostridopeptidase A (E.C. 3.4.24.3) from *Clostridium histolyticum* Type XI (Sigma, St. Louis, MO) (see **Notes 1** and **2**).
5. Ficoll Type 400DL (Sigma, St. Louis, MO): A 25% (w/w) Ficoll stock solution is prepared by dissolving one 500-g container of Ficoll 400DL into 1500 mL of HEPES HBSS in a 2-L beaker. The 25% Ficoll stock is sterilized in 500-mL bottles in approx. 400-mL aliquots for 30 min with slow exhaust. Following cooling to room temperature, 2.5 mL of penicillin/streptomycin is added to 500 mL Ficoll, the solution is mixed and stored at 4°C. This will be the stock solution from which all other dilutions will be made.
6. Siliclad reagent (Gelest, Tullytown, PA): Dilute and treat glassware according to manufacturer's specifications. All glass items that contact tissue or islets, including test tubes, Pasteur pipets, and evaporating dishes must be treated with Siliclad, as the tissue/islets will stick to untreated glass.
7. 70% ethanol

2.3. Rat Surgery

1. One presterilized surgical pack containing the following:
 - a. One pair of 5-in. operating scissors.
 - b. One pair of curved iris scissors.

- c. One small curved, nontoothed eye dressing forceps.
 - d. One medium straight nontoothed dressing forceps.
 - e. One 6-in. toothed lab forceps.
 - f. One 2- to 3-in. precut piece of 4-0 silk ligature per animal.
 - g. One straight Halsted mosquito hemostat per animal.
 - h. One 4 × 4 gauze pad per animal.
2. 20-cm³ syringes with LuerLok[®] (one per animal).
 3. One cannula per syringe. Each cannula consists of a 7- to 10-inch piece of Intramedic PE 50 tubing attached to either a 23-gauge Luer stub adapter or a 23-gauge needle. The opposite end of PE 50 tubing should have a 45° bevel cut with scissors or a sharp blade.

2.4 Mouse Surgery

1. One presterilized surgical pack containing the following:
 - a. One pair of straight iris scissors.
 - b. One curved, nontoothed eye dressing forceps.
 - c. One curved, toothed eye dressing forceps.
 - d. One straight dressing forceps.
 - e. One Dieffenbach micro serritine clamp.
 - f. One 4 × 4 gauze pad.
 - g. One 2 × 2 gauze pad for each mouse.
2. One 5- or 10-cm³ syringe with LuerLok[®].
3. One 30-gauge needle, bent at a 90° angle.
4. Dissecting microscope with overhead light source.
5. One small beaker containing approx 15 mL HBSS on ice.

2.5. Islet Isolation Procedure

All glassware is siliconized as described in **Subheading 2.2.**

1. Two pairs of straight iris scissors, sterilized.
2. Glass evaporating dish.
3. Pasteur pipets.
4. 16 × 100 glass culture tubes.
5. Two to four sterile, 15-mL glass conical tubes.
6. Sterile, disposable pipets and Pipet-Aid[®].
7. Parafilm[®], precut 1-in. strips.
8. 60 × 15-mm Petri dishes, nontissue culture treated.
9. Sterile rubber stoppers size 0, one per test tube.

3. Methods

The method used to isolate pancreatic islets is based on the protocol originally developed by Lacy with some modifications (2–4).

3.1. Rat Pancreas Isolation

The following procedure is used for isolating pancreata from rats weighing 150–300 g. For optimal success, the procedure should be performed as quickly as possible to avoid tissue degradation. This protocol can be used to isolate pancreata from one to five rats during a single isolation. It is not recommended to use more than five rats per isolation because of the extended time for pancreas removal. The protocol anticipates that the total surgery time will be no longer than 30 min for a five-rat isolation. The surgery should be treated as a sterile procedure, although it is acceptable to perform the procedure on a bench top with care.

1. Prepare a minimum of 200 mL HBSS and fill each 20-cm³ syringe with cold HBSS (use one 20-cm³ syringe per rat). Attach the cannulas to each 20-cm³ syringe.
2. Anesthetize rats using approved institutional animal care guidelines. Once anesthetized, wet the abdominal fur with a 4 × 4 gauze pad soaked in 70% ethanol. Place the rat on its back with the head toward the surgeon. Make a midline incision of the skin down the abdomen using the large forceps and operating scissors. The incision should begin at the sternum and end at the level of the symphysis pubis. Wipe off the blades of the scissors with an ethanol-soaked gauze pad after the first incision to remove any fur. Make a second midline incision following the linea alba, from the sternum to the symphysis pubis, through the abdominal musculature and peritoneum to expose the internal organs.
3. Lay the edge of an unfolded gauze pad at the sternal edge of the incision. Using both hands, gently apply pressure at the edge of the gauze using a downward motion to flip all of the lobes of the liver cephalad. Secure the lobes with the free unfolded flap of the gauze. This will expose the common bile duct.
4. Locate the point at which the common bile duct enters the duodenum. Using the Halsted hemostat, clamp off the duct at the point where it enters the duodenum. Gently lay the hemostat in a position parallel with the animal's body. This will create tension on the duct and will slightly raise it for easier cannulation.
5. Locate the area where the common bile duct bifurcates into the dorsal lobes of the liver (*see Fig. 1A*). Using the small curved eye dressing forceps, make a small hole in the connective tissue just under and caudal to the bifurcation. Thread a piece of ligature through the hole and under the common bile duct with the small curved forceps. Tie a loose single knot just above the bifurcation. This will hold the cannula in the duct, once in place.
6. Using the small curved iris scissors, make a small cut on the top of the widest part of the bifurcation. Be careful not to cut through the duct. Insert the cannula into the common bile duct through the hole at the bifurcation, with the bevel facing downward. Gently tighten the ligature around the cannula to secure it in the duct.
7. Inject HBSS into the pancreas at a rate of approx 6 mL/min. By injecting too quickly, the increased pressure can cause the outer capsule of the pancreas to burst and full inflation will not be achieved.

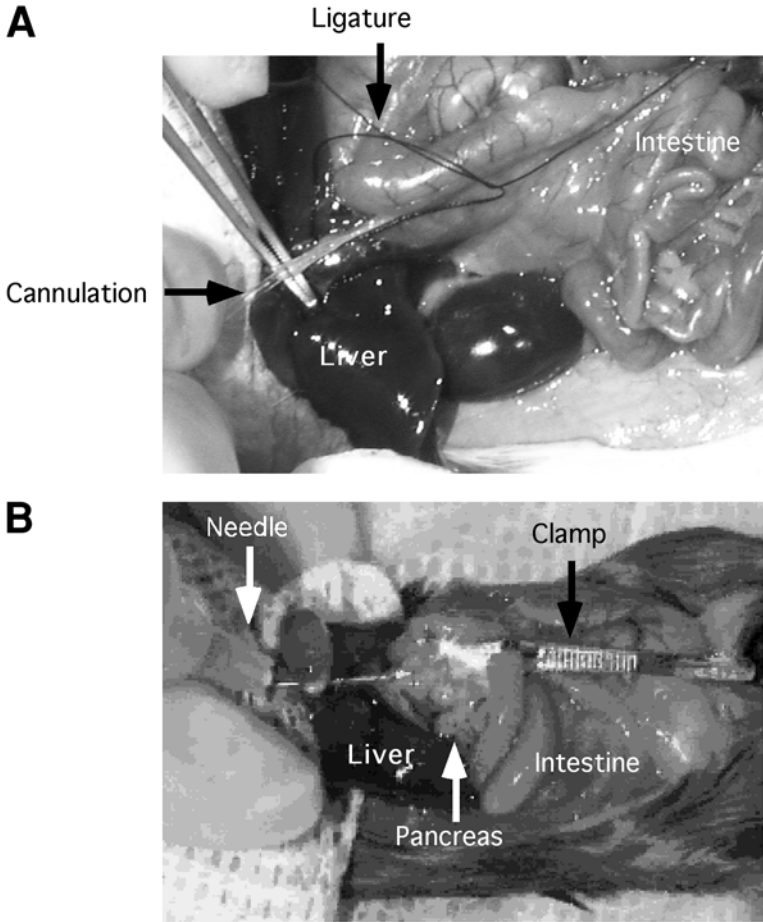

Fig. 1. Cannulation of the common bile duct. These figures shows the cannulation point in a rat (A) and mouse (B) common bile duct. Note that the ligature knot placement is caudal to the insertion point of the cannula in the rat and that the clamp is placed at the juncture of the duct entering the duodenum in the mouse.

8. Once the pancreas is inflated, remove the cannula, hemostat, and ligature. Using the small curved eye dressing and straight dressing forceps, gently tease the inflated pancreas away from the small intestine, the spleen, and the stomach. The remaining attachments will be near the great vessels deep in the abdominal cavity. Remove the remaining tissue by placing the forceps underneath the tissue and lifting upward. To prevent excessive tissue degradation, the pancreas should be removed in one piece.
9. Place the pancreas in a small beaker containing approx 10 mL cold HBSS and keep on ice. Once all the pancreata are excised, remove any fatty tissue, visible lymph

nodes, and blood clots from the pancreas by moving it to a Petri dish and cutting away the unwanted tissues with the small curved iris scissors and curved forceps. This cleaning procedure should be completed as quickly as possible. The pancreata are now ready for digestion and isolation.

3.2. Mouse Pancreas Isolation

The protocol for the rat surgical procedure can be followed with the following exceptions. First, the entire procedure must be performed under a dissecting microscope, with a strong overhead light source. Second, the common bile duct is clamped with a Dieffenbach micro serritine clamp instead of the Halsted hemostat (*see Fig. 1B*). Third, the common bile duct is cannulated with a 30-gauge needle attached to a syringe filled with 5 mL HBSS instead of a PE 50 cannula on a 20-cm³ syringe. Each mouse pancreas should be injected with approx 2–3 mL HBSS. Finally, a ligature to secure the cannula is not necessary and fat and lymph nodes need not be removed from the isolated pancreata. Once removed from the animal, the tissue is ready to be digested. As the procedure must also be performed quickly to prevent tissue degradation, pancreata should not be isolated from more than 15 mice at a time. With two surgeons, up to 30 pancreata can be isolated without compromising islet yield. The total isolation time should take no more than 30 min.

3.3. Islet Purification from Rodent Pancreas

The same general protocol is used for the purification of islets from mouse and rat pancreata. All media used for islet isolation should be equilibrated to room temperature except the HBSS. Note that this entire procedure, excluding centrifugation and digestion, should be performed using sterile technique.

1. A 5-rat or 25-mouse preparation will require a minimum of 500 mL HBSS, a maximum of 500 mL cMRL-1066, Ficoll dilutions (20 mL of 25% dilution and 10 mL of 23%, 20.5%, and 11% dilutions), and collagenase (one preweighed volume per tube).
2. Begin by placing the isolated pancreata into the evaporating dish. Using both pairs of sterile straight iris scissors, chop the tissue into small evenly sized pieces (*see Fig. 2*) to ensure even and consistent digestion.
3. Wash the minced pancreatic tissue using HBSS two to three times. This can be accomplished by quickly pouring off the HBSS and refilling the evaporating dish with fresh HBSS. Allow the tissue to settle to the bottom for 5–10 s between washes. Pancreatic tissue should sink, and the adipose tissue that floats should be discarded.
4. Using a siliconized sterile Pasteur pipet that has been cut to remove the narrow tip, transfer the pancreatic tissue from the evaporating dish and evenly distribute the tissue into sterile, siliconized 16 × 100 glass culture tubes (tissue must be distributed evenly in the test tubes for proper digestion). The average tissue volume per tube

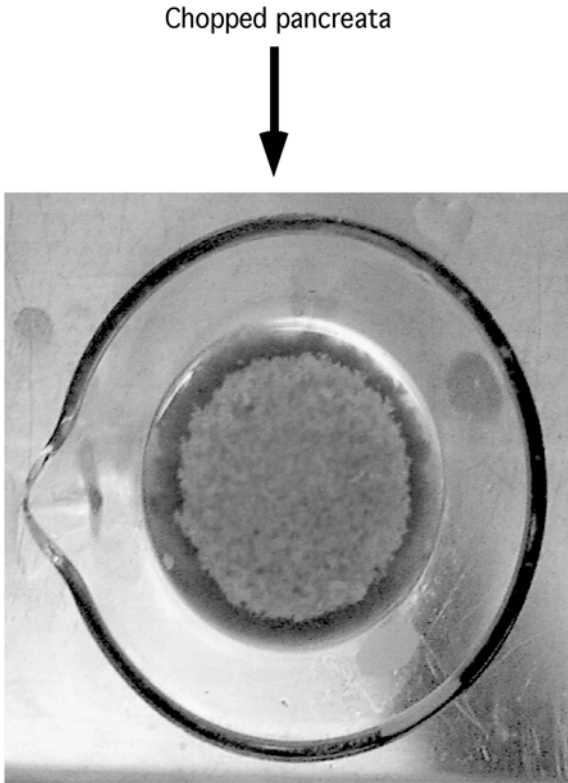

Fig. 2. Preparation of pancreata for collagenase digestion. The chopped pancreata in this evaporating dish demonstrate the small, even size of tissue fragments ideal for optimum collagenase digestion.

should be approx 3 mL. For ease of preparation, one test tube holds the equivalent of one rat or five mouse pancreata.

5. Allow the tissue to settle to the bottom of the tubes for 5–10 s. Using the same Pasteur pipet, remove as much HBSS as possible from the top of the tissue. There should be approx 1 mm of media remaining on the top of the tissue.
6. Quickly add the premeasured collagenase to each tube, plug tubes with sterile rubber stoppers, and use Parafilm[®] strips to secure the stoppers in the tubes (*see Notes 1 and 2*).
7. Place the tubes into the wrist-action shaker clamps (which are set to shake the tubes horizontally) submerged into a 38–39°C water bath. Be sure that the shaker is set at the maximum arc and turn the timer to the hold position. Allow the tubes to shake for the appropriate amount of time as determined for each lot of collagenase (*see Note 3*).
8. Once digestion is complete, stop the collagenase reaction by quickly pouring approx 8 mL cold HBSS into the test tubes (*see Note 4*).

9. Shake the tubes vigorously by hand to dilute the collagenase solution and pellet the tissue by centrifugation. This is accomplished by bringing the centrifuge up to 805g and then immediately stopping the spin with the brake engaged.
10. Quickly decant the supernatant and repeat two additional times as outlined in **step 9**, bringing the centrifuge up to 453g each time. After the last spin, before decanting the supernatant, remove the foam layer on the top of the media with a standard Pasteur pipet. Then, quickly decant the supernatant and remove the last drop of media from the tube with the Pasteur pipet.
11. Add 4 mL of 25% Ficoll to each tube using a disposable pipet, and vortex the tube at approximately three-quarters speed. Using the Pasteur pipet, gently remove any mucin from the mixture. Mucin is the byproduct of the collagenase digestion, which appears as a gelatinous body that should be removed from the tissue mixture. To remove it, gently swirl a Pasteur pipet in the mixture. The mucin will adhere to the pipet and can be discarded (*see Fig. 3*). Note that mucin will not always be present in each digestion and can vary from tube to tube.
12. Once the mucin is removed, prepare a Ficoll step gradient by slowly layering 2 mL 23% Ficoll, 2 mL of the 20.5% Ficoll, and 2 mL of 11% Ficoll to each tube (*see Fig. 4*) (*see Note 5*). Spin the tubes at 800g for 12 min at room temperature with no brake.
13. Once the spin has completely stopped, return the tubes to the hood. Using the Pasteur pipet, remove islets from the 11–20.5% interface and place into one to two sterile 15-mL-thick-walled glass conical tubes containing 2 mL HBSS.
14. Repeat this procedure for the 20.5–23% interface and place islets into one or two separate conical tubes. Following transfer of material at each interface, fill each conical tubes with HBSS to a final volume of approx 12 mL.
15. Resuspend the pellet by pipetting up and down with a Pasteur pipet until the Ficoll is completely mixed with the HBSS. Centrifuge the tubes at 805g for 20–30 s and stop with the brake. Decant the supernatant and repeat this procedure two additional times.
16. Add 6 mL cCMRL-1066 to the pellet and resuspend the islets using a Pasteur pipet. Spin the tubes for 5 s (including acceleration time) and immediately stop the spin. Decant the supernatant of each tube into a separate 60 × 15-mm Petri dish and save.
17. Repeat this washing step two more times, decreasing the centrifugation time by 1 s for each wash.
18. Once the washes are complete, add 4 mL CMRL media to each tube, and using the pipet, transfer the remaining pellet into a separate Petri dish.
19. Using a flame-pulled Pasteur pipet and dissecting microscope, remove all of the duct and acinar tissue that remain in each dish. This can be accomplished by either selectively moving the islets to new, clean Petri dishes or swirling the plate and sucking off the acinar and ducts and discarding them into a waste container. Replace cCMRL-1066 as needed during the cleaning process. The preparation should be free of as much extraneous tissues as possible to ensure optimum islet culture conditions.
20. Once the preparation is free of all acinar and ductal tissues, divide the total pooled islets (300–600 islets/rat or 80–180 islets/mouse) into four fresh 60 × 15-mm Petri

digested tissue
in 25% ficoll

mucin

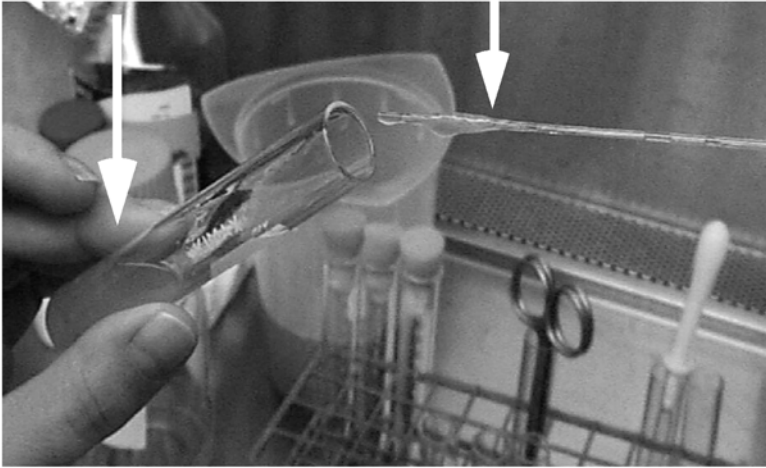

Fig. 3. Removal of mucin. Mucin is a byproduct of the collagenase digestion. It is important to remove this byproduct from the remaining pancreatic tissue prior to Ficoll gradient centrifugation.

dishes. There should be no more than 300 islets per dish for optimum culture conditions. Remove all media and add 2–2.5 mL fresh cMRL-1066 per Petri dish. The islets can now be cultured at 37°C with 5% CO₂ for 1–3 d. If a longer culture time is desired, the media should be replaced after 3 d (*see Notes 6 and 7*).

4. Notes

1. Identifying the appropriate source, amount, and type of collagenase to be used for islet isolation is the most challenging aspect of the isolation of islets from rodent pancreata. The activity of collagenase is highly variable and dependent on source, supplier, and specific lot. We routinely use Type XI collagenase (Sigma, St. Louis, MO), although many laboratories use type P collagenase from Boehringer-Mannheim (Indianapolis, IN). Both of these sources of collagenase are specifically designed for pancreas digestion. It is critical to assess the activity of individual lots of collagenase, as the activity is highly variable. It is best to test several different lots of collagenase before purchasing a large supply of a specific lot. The activity of each lot should be consistent throughout.
2. There are three important variables to consider when choosing a lot of collagenase: (1) the amount of collagenase required to fully digest the pancreas, (2) the length of time for the digestion, and (3) the amount of pancreas to be digested. It is best

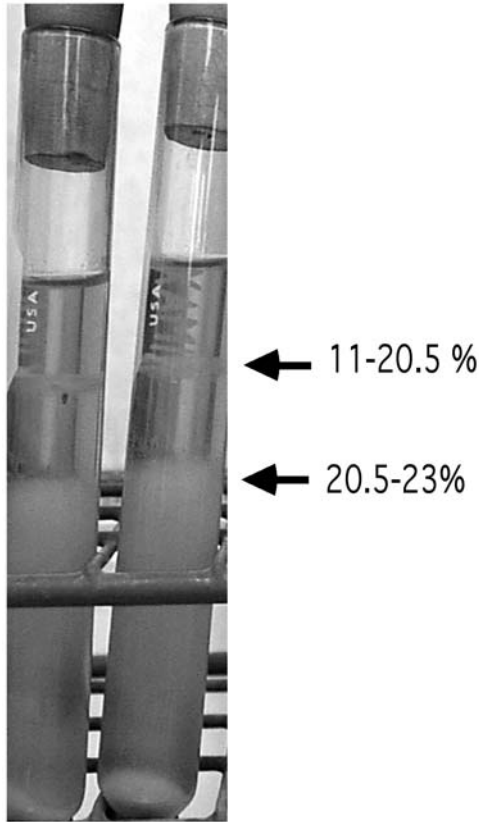

Fig. 4. Ficoll gradient centrifugation. The yield of islet in each gradient interface can vary depending on the digestion. The top interface (11–20.5%) will provide the highest yield of mouse islets. The second interface (20.5–23%) will provide the highest yield of rat islets. It is important to note that for each animal type, islets will be present at both interfaces.

to begin by testing several different combinations (amount of collagenase used for the digestion and time of digestion) and compare the resulting yield of islets with a known lot of enzyme. We routinely initiate our characterization of a new lot of collagenase by varying the amount of collagenase. We start with 12–16 mg collagenase per tube of minced pancreas. Using equivalent volumes of pancreatic tissue in each test tube will help ensure consistency between tubes. The time of digestion is also a very critical parameter in a successful islet isolation.

3. When testing a new lot of collagenase, we usually begin with a 3.5- to 4-min digestion period. If the time required to digest the pancreatic tissue exceeds 7–7.5 min, increase the amount of collagenase. This will decrease the digestion time and also decrease islet damage that may occur during the digestion. While testing various

lots of collagenase, the tissue volume should remain close to 3 mL. This volume should also include the 1 mm of HBSS remaining on the top of the tissue. If the tissue volumes are a bit smaller or larger, adjust the digestion time accordingly.

4. The end point for the collagenase digestion is determined visually. A good end point will have no visible tissue chunks remaining. It should appear smooth with a “creamy” texture. When holding the tubes up to the light, translucent gelatinous “spotting” that will run down the sides of the tube should be apparent. If there are large tissue chunks, return to the tubes to the water bath and shake for another 30 s. Repeat until you obtain the desired visual end point. If the material appears smooth, with no chunks, but has no spotting, continue to shake the tubes by hand at room temperature until the spotting appears. This change can take anywhere from several seconds to a couple of minutes. An underdigested islet preparation is characterized by a high level of acinar or ductal tissue attached to the islets. An overdigested islet preparation will have small ducts and little to no acinar cells, and the islets will have rough edges (islets with rough edges may recover following an overnight culture). In extreme cases of overdigestion the islets will disintegrate into single cells following an overnight culture. A normal, healthy islet will appear round with smooth edges.
5. One source of potential problems with the Ficoll preparation method of islet isolation is poor gradients or aberrant migration of islets in the Ficoll step gradients. To reduce potential problems with the islet Ficoll gradients, it is recommended that the refractive index of the Ficoll dilutions be examined to determine if the stock solutions are at the proper density for islet isolation. The following table gives the correct index and density values for each dilution.

Ficoll	Index	Density
25%	1.376	1.0786
23%	1.373	1.0766
20.5%	1.368	1.0720
11%	1.352	1.060

6. Using the above-outlined protocols, one can expect to obtain approx 300–600 islets from each rat pancreas. On average, the yield from a mouse pancreas is lower, on the order of 80–180 islets. The yield of islets from transgenic animals may vary depending on the transgene expressed in islets or the effects of the specific transgene or gene knockout on β -cell development.
7. Once islets have been isolated, a number of additional manipulations can be performed. Islets can be dispersed into individual cells. This is routinely performed by trypsin treatment, as outlined previously (5,6). It is also possible to purify individual endocrine cells from islets by fluorescence-activated cell sorting (FACS). The technology for FACS purification of β -cells and non- β -cells was originally developed by Pipeleer’s laboratory (7; see also Chapter 2). We routinely obtain approx $1.2\text{--}2 \times 10^6$ purified β -cells and approx $5\text{--}8 \times 10^5$ non- β -cells from islets isolated from 10 rats. The purity of these preparations is dependent on the parameters of FACS sorting, but in most purifications, we obtain approx 90–95% pure β -cells. The non- β -cell preparations contain primarily α -cells (approx 60%) as well as some

β -cells, endothelial cells, and fibroblasts. The use of FACS-purified β -cells provides a unique method to directly examine the function of primary β -cells in the absence of other islet cellular components (8).

Acknowledgments

The authors thank Dr. Michael Moxley for assistance with the preparation of this review. This work was supported by NIH grants DK-52194 and AI44458 to JAC.

References

1. Scarim, A. L., Heitmeier, M. R., and Corbett, J. A. (1997) Irreversible inhibition of metabolic function and islet destruction after a 36-hour exposure to interleukin-1 β . *Endocrinology* **138**, 5301–5307.
2. Lacy, P. E. and Kostianovsky, M. (1967) Methods for the isolation of intact islets of Langerhans from the rat pancreas. *Diabetes* **16**, 35–39.
3. Scharp, D. W., Kemp, C. B., Knight, M. J., Ballinger, W. F., and Lacy, P. E. (1973) The use of Ficoll in the preparation of viable islets of Langerhans from the rat pancreas. *Transplantation* **16**, 686–689.
4. Kostianovsky, M., McDaniel, M. L., Still, M. F., Still, R. C., and Lacy, P. E. (1974) Monolayer cell culture of adult rat islets of Langerhans. *Diabetologia* **10**, 337–344.
5. Scarim, A. L., Arnush, M., Blair, L. A., et al. (2001) Mechanisms of β -cell death in response to double-stranded (ds) RNA and interferon- γ . *Am. J. Pathol.* **159**, 273–283.
6. McDaniel, M. L., Colca, J. R., Kotagal, N., and Lacy, P. E. (1983) A subcellular fractionation for studying insulin release mechanisms and calcium metabolism in islets of Langerhans. *Methods Enzymol.* **98**, 182–200.
7. Pipeleers, D. G., Int Veld, P. A., Van De Winkel, M., Maes, E., Schuit, F. C., and Gepts, W. (1985) A new in vitro model for the study of pancreatic α and β -cells. *Endocrinology* **117**, 806–816.
8. Heitmeier, M. R., Scarim, A. L., and Corbett, J. A. (1997) Interferon- γ increases the sensitivity of islets of Langerhans for inducible nitric-oxide synthase expression induced by interleukin-1. *J. Biol. Chem.* **272**, 13,697–13,704.

Purification of Rat Pancreatic β -Cells by Fluorescence-Activated Cell Sorting

Geert Stangé, Mark Van De Castele, and Harry Heimberg

1. Introduction

The β -cell is receptive to intricate hormonal, neuronal and nutrient signaling which is key for normal physiology but complicates the study of specific effects of individual factors on β -cell function. To preserve the microenvironment of the β -cell, most studies of β -cell physiology have been performed on in vitro cultured islets of Langerhans. However, whereas islets in the pancreas are highly vascularized and oxygenated, ischemic conditions cannot be avoided in the center of cultured isolated islets, leading to abnormal islet cell function and viability. Moreover, in the absence of blood flow, intercellular communication in islets is likely to change as well. Furthermore, contamination of islets with anatomically associated acinar cells is inevitable during isolation and may have a major influence on the specificity of experiments.

To avoid the above interactions, β -cells need to be investigated at the single-cell level. Much of the analytical information has been obtained by clamping individual islet cells to study their electrophysiology and by reverse hemolytic plaque assay to visualize the insulin release from individual β -cells (1). However, purification of the individual cell types at the preparative level is necessary to study (sub)cellular mechanisms of hormone synthesis and secretion under normal and pathological conditions. Depending on the available equipment and on the aim of the study, islet cells can be isolated on the basis of differences in cell size (2), membrane antigens (3) or metabolic features (4,5–6). The resulting cell purity and viability will differ according to the method used. This chapter presents a protocol for rat islet cell purification on the basis of dif-

ferences in light scatter and endogenous fluorescence, thus combining the first and third methods. Increased light scatter, in combination with high levels of the autofluorescent electron carrier flavine–adenine–dinucleotide (FAD) allows the isolation of β -cells at greater than 95% purity (4). This model has proven very useful for studying regulation of β -cell (dys)function and functional cooperation between islet cells (7). In addition, acute changes in the redox state of endogenous nicotinamide dinucleotide (phosphate) [NAD(P)H] serve as a basis for further cell separation (5). This parameter directly correlates to changes in the cellular redox state induced by (glucose) metabolism and allows definition of distinct β -cell populations according to their nutrient responsiveness (8,9). Moreover, α -cells exhibit stable NAD(P)H pools and can also be purified on the basis of this parameter. The availability of large amounts of pure α - and β -cells that are functionally intact and support long-term, serum-free culture has facilitated detailed studies on the regulation of hormone synthesis and secretion (10–13), on cell survival and protection of the differentiated phenotype (14–17), and on the molecular biology of cellular heterogeneity (18–20).

2. Materials

Adult male Wistar rats (SPF, Han, 6 wk of age and 200–300 g body weight; Elevage Janvier, Le Genest St. Isle, France).

2.1. Reagents

All media are sterilized by filtration through a 0.22- μ m filter.

1. Isolation medium: 123 mM NaCl, 1.8 mM CaCl₂, 0.8 mM MgSO₄, 5.4 mM KCl, 1 mM NaH₂PO₄, 5.6 mM glucose, 4.2 mM NaHCO₃, 10 mM HEPES, 0.5% bovine serum albumin, 0.1 g/L kanamycine (pH 7.4) at room temperature.
2. Dissociation medium: 125 mM NaCl, 0.8 mM MgSO₄, 5.4 mM KCl, 1 mM NaH₂PO₄, 5.6 mM glucose, 4.2 mM NaHCO₃, 10 mM HEPES, 0.5% bovine serum albumin, 0.1 g/L kanamycine, 7.41 mM EGTA (pH 7.4) at 30°C.
3. Cell culture medium: Nutrient mixture Ham's F-10, without glutamine, without glucose (Gibco Laboratories) supplemented with 2 mM L-glutamine, 10 mM glucose, 0.075 g/L streptomycin, 0.1 g/L penicillin, 0.5 g/L bovine serum albumin (factor V, RIA grade, Sigma), 50 μ M 3-isobutyl-1-methylxanthine (Sigma).

2.2. Equipment

Materials are autoclaved or purchased as sterile disposables. Glassware used for collecting islets or cells is treated with silicon solution (Serva, Heidelberg, Germany) for 1 min, followed by three successive washes in distilled water. When dry, the material is sterilized in an oven for 6 h at 180°C.

1. Heated shaker TH25 (Edmond Bühler, Germany).
2. Elutriator JE-X10 X10 (Beckman, Palo Alto, CA).
3. Enterprise II argon laser (Coherent, Santa Clara, CA).
4. FACSTAR Plus (Becton Dickinson, Sunny Vale, CA, USA).
5. Discardit II 10-mL syringe (Becton Dickinson, Heulva, Spain).
6. Catheter tube PTFE, internal diameter of 0.6 mm, external diameter of 0.9 mm (Merck, Darmstadt, Germany).
7. 50-mL propylene conical tube (Becton Dickinson, Franklin Lakes, NJ, USA).

3. Methods

3.1. Dissection of the Rat Pancreata

1. Adult male Wistar rats are intraperitoneally injected with pilocarpine (200 μ L per 200 g body weight) 2 h before dissection. Pilocarpine is 4% isoptocarpine.
2. Rats are sedated by treatment with CO₂ and killed by decapitation.
3. After ligation of the pancreatic duct with a Halsted-mosquito forceps, a small incision is made in the pancreatic duct, close to the liver.
4. The pancreata are distended by injection of 10 mL cold isolation medium containing 0.3 mg/mL collagenase (use a 0.6- μ m-internal-diameter catheter mounted on an 18-gauge needle placed on a 10-mL syringe).
5. The glands are removed and cleaned from lymph nodes and fat tissue. Four to five pancreata are collected in a 50-mL tube and kept on ice until digestion (*see Notes 1 and 2*).

3.2. Collagenase Digestion

1. Dissected pancreata are predigested by incubation at 37°C, under continuous shaking (240 strokes/min).
2. After 5–6 min, the supernatant fluid is discarded and the tissue is minced with scissors. Isolation medium is added and after 15 s of sedimentation, the supernatant is discarded.
3. The tissue suspension is then diluted with 1 volume of isolation medium containing 0.3 mg/mL collagenase P and further digested in the air-heated shaker for an additional 15–18 min under continuous shaking at 37°C (*see Note 3*).
4. The digested tissue is then gently resuspended and the digestion is stopped by filling the tube with isolation medium with 2% heat-inactivated fetal calf serum.
5. The digest is then filtered through a 500 μ m nylon screen and the filtrate is washed twice by adding 30 ml of isolation medium followed by centrifugation for 2 min at 240g.
6. The filter residue is resuspended in isolation medium without collagenase and further dispersed by shaking manually and filtering through a 500 μ m nylon screen. The additional filtering of undigested residues is repeated twice. All the digested fractions are then collected and washed in a 50 mL tube.

3.3. Islet Purification

Conditions of centrifugal elutriation allow elimination of particles smaller than 100 μm in diameter. The technique involves the use of a 10X elutriator rotor installed in a JB6 centrifuge.

1. The pancreatic digest is suspended in the mixing chamber that is connected to a flask containing isolation medium.
2. With the elutriator running at 250 rpm, the cellular material is perfused into the elutriation chamber at a rate of 230 mL/min. Particles larger than 100 μm in diameter are retained in the elutriation chamber; smaller fragments leave the rotor and are discarded.
3. After disposal of 800–900 mL eluent, the elutriation chamber is disconnected from the circuit and the centrifugation speed is turned down to zero. While the centrifuge is slowing down, the content of the elutriation chamber is collected (*see Note 4*).
4. The elutriation is stopped when 500 mL eluent has been collected. The fraction is examined under an inverted dissection microscope. Clean islets are hand-picked with an elongated Pasteur pipet (*see Notes 5 and 6*).

3.4. Dissociation

1. The isolated islets are washed twice, by sedimentation in isolation medium, followed by a wash in dissociation medium.
2. Islets are resuspended in 30°C dissociation medium and transferred to a siliconized 100-mL bottle.
3. The islet preparation is transferred to an air-heated shaker at 30°C and incubated for 5 min under continuous shaking (200 rpm).
4. After a brief resuspension of the islets with a siliconized Pasteur pipet, the medium is supplemented with trypsin and DNase at a final concentration of 5 $\mu\text{g}/\text{mL}$ and 2 $\mu\text{g}/\text{mL}$, respectively.
5. The degree of dissociation is regularly checked under a phase-contrast microscope and stopped when 50–60% of the cells occur as single-cell units, which is usually the case after 10 min. The dissociation is stopped by adding 2% fetal calf serum (FCS) to the isolation medium.
6. In order to remove cell debris and dead cells, an isotonic Percoll solution with a density of 1.040 g/mL is layered underneath the suspension and the gradient is centrifuged at 800g for 6 min (no break).
7. The pellet is collected and suspended in 50 mL isolation medium, which is then filtered through a 63- μm nylon screen to remove the rare, large-cell clumps.
8. The filtrate is washed in Ham's F-10 containing 6 mM glucose, 1% bovine serum albumin (fraction V), 2 mmol/L L-glutamine. The cells are cultured in suspension for 30 min at 37°C in 95% air–5% CO₂ prior to fluorescence-activated cell sorting (*see Note 7*).

3.5. Purification of Single β -Cells and Non- β -Cells

1. The dispersed islet cells are washed in isolation medium containing 2.8 mM glucose and submitted to auto-fluorescence-activated cell sorting (FACS) using a FAC-

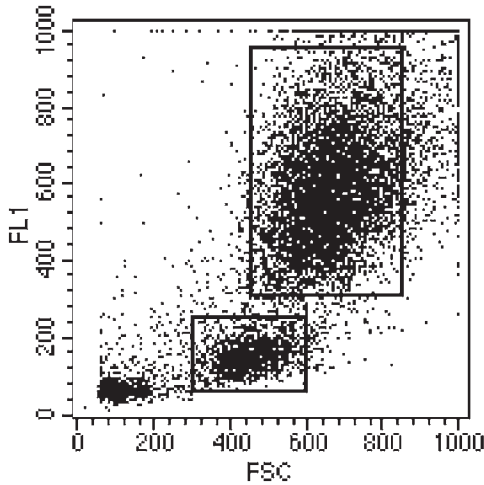

Fig. 1. FACS analysis of unpurified islets cells examined for their FAD fluorescence and FSC intensity at 2.8 mM glucose. The subpopulation with high FAD and high FSC represents the β -cells, whereas the islet non β -cells are lower in FAD content and cause less FSC.

STAR PLUS. Isolation medium is used as sheath fluid. A 0.22- μ m filter is put on the sheath tank to remove any particles in the medium.

- The cells are illuminated with an argon laser (Enterprise II) with 100 mW at 488 nm. The instrument is calibrated according to the manufacturer's guidelines. The fluorescence emission is collected in the FL1 photomultiplier at 510–550 nm (FITC filter, 530-nm bandpass filter). The fluorescence can be taken as a parameter for the cellular FAD content. Rat β -cells have a threefold higher FAD fluorescence than rat non- β -cells at this low glucose concentration. The β -cells are larger than the non- β -cells and have thus a larger forward scatter (FSC). The background signal caused by cell debris is removed by putting a threshold level on FSC. Both FSC and FL1 are linearly amplified.
- Selection of the appropriate windows allows the simultaneous isolation of single β -cells and single islet non- β -cells. The β -cells are separated on the basis of high FAD fluorescence and high FSC as compared to non- β -cells (**Fig. 1**). The cells in uncharged droplets are collected as well. They constitute the so-called "middle fraction." The middle fraction is collected in a 50-mL tube, spun down (5 min at 500g), resuspended in low-glucose-containing isolation medium and re-sorted (*see Note 8*).

3.6. Culturing of Purified β -Cells

- Single rat β -cells do not survive well in suspension. To avoid β -cell losses, FACS-purified rat β -cells are reaggregated in a rotatory shaker for 2 h at 37°C and 5% CO₂, in the presence of Ca²⁺ (*see Note 9*).

2. Aggregated β -cell clusters can be kept in suspension in serum-free HAM's F10 medium at 37°C and 5% CO₂. Depending on the experiment, cultures can be maintained in the absence or presence of 50 μ M IBMX. The phosphodiesterase inhibitor mimics paracrine hormone actions on the β -cells, stimulating their in vitro survival and function.
3. β -cells can also be cultured as single cells in poly-D-lysine-coated tissue culture plates with good survival rates. Ninety-six-well plates are coated by incubating the wells with 100 μ L of poly-D-lysine (Sigma, 10 μ g/mL in water) for 30 min at 30°C, followed by three successive washes with Ham's F10 medium.

3.7. Assessment of the Quality of the Purified β -Cells

1. The viability is assessed by the addition of the vital stain neutral red (final concentration 0.01% [w/v] in isolation medium) to a suspension of purified cells. After incubation for 5 min at 37°C, red-stained cells are counted under a light microscope. Immediately after sorting, an average of more than 95% of the purified cells incorporate the dye.
2. The purity of the cell preparation is analyzed by immunocytochemistry by visualizing the islet hormones and by measuring islet hormone levels by utilizing radioimmunoassays.
3. Functional and metabolic activities are evaluated by measuring the glucose response of insulin biosynthesis and secretion, glycolysis, and oxidation.

4. Notes

1. It is important to proceed as soon as possible with the digestion; therefore, the dissection should be done fast. On average, one person should be able to process five rats within 30 min.
2. It is of crucial importance to test different batches of collagenase for their yield and toxicity. Therefore, the number of β -cells that survive the isolation and can be kept in culture without losing their functional responsiveness is determined by the quality of the collagenase. The concentration of the collagenase needs to be adapted according to both parameters (cell survival and functional responsiveness after isolation). For each isolation procedure, the collagenase solution has to be made freshly. The collagenase crystals are dissolved in isolation medium, the pH is adjusted to pH 7.4, and the solution is sterilized by filtration.
3. Progression of the digestion is closely monitored. The optimal duration of digestion varies with different batches of collagenase. An average of digesting for 20 min is achieved by adjusting the concentration of the collagenase solution. Once the digest has a milky appearance, the reaction is stopped.
4. All handling is done in a laminar-flow hood. No visible acinar cell mass should contaminate the hand-picked islets. Islets appear compact, bright, and white, whereas acinar tissue is fluffy and gray.
5. This procedure yields 7000–12,000 islets from 20 rat pancreata within 2–3 h after starting the dissection. Using this technique, only the larger-size islets of more than

100 μm are selected. This islet fraction represents more than 50% of the total insulin content of the adult rat pancreas.

6. Instead of being discarded, the fraction that is smaller than 100 μm is very suitable for use as a preparation enriched in acinar cells and small islets. Cellular composition: The "smaller than 100 μm " elutriation fraction contains less than 2% endocrine material, whereas the "larger than 100 μm " fraction is enriched in endocrine material up to 10%. After the islets have been hand-picked, this endocrine fraction contains 70–80% endocrine cells and less than 10% exocrine cells. Approximately 30% of the insulin hormone content is recovered in the "smaller than 100 μm " fraction and 60% in the "larger than 100 μm " fraction. The islet-enriched fraction contains 50% of the total insulin content.
7. The final cell suspension usually contains 5×10^5 to 1×10^6 cells per pancreas when starting from 20 rat pancreata.
8. The β -cell population consists of more than 95% insulin-containing cells and comprises less than 3% of glucagon-, somatostatin-, or pancreatic polypeptide-containing cells. Between 92% and 100% of the cells are single. The non- β -cell subpopulation consists of 75–85% glucagon-, 2–5% insulin-, 5–10% somatostatin, and 5–10% pancreatic polypeptide-expressing cells.
9. Cultured aggregates of β -cells display much less central necrosis, as compared to cultured islets, probably because of increased oxygen and nutrient diffusion.

References

1. Salomon, D. and Meda, P. (1986) Heterogeneity and contact-dependent regulation of hormone secretion by individual B cells. *Exp. Cell. Res.* **162**, 507–520.
2. Pipeleers, D. G. and Pipeleers-Marichal, M. A. (1981) A method for the purification of single A, B and D cells and for the isolation of coupled cells from isolated rat islets. *Diabetologia* **20**, 654–663.
3. Russell, T. R., Noel, J., Files, N., Ingram, M., and Rabinovitch, A. (1984) Purification of beta cells from rat islets by monoclonal antibody-fluorescence flow cytometry. *Cytometry* **5**, 539–542.
4. Van De Winkel, M., Maes, E., and Pipeleers, D. (1982) Islet cell analysis and purification by light scatter and autofluorescence. *Biochem. Biophys. Res. Commun.* **107**, 525–532.
5. Van De Winkel, M. and Pipeleers, D. (1983) Autofluorescence-activated cell sorting of pancreatic islet cells: purification of insulin-containing B-cells according to glucose induced changes in cellular redox state. *Biochem. Biophys. Res. Commun.* **114**, 835–842.
6. Pipeleers, D. G., in 't Veld, P. A., Van De Winkel, M., Maes, E., Schuit, F. C., and Gepts, W. (1985) A new in vitro model for the study of pancreatic A and B cells. *Endocrinology* **117**, 806–816.
7. Pipeleers, D. (1987) The biosociology of pancreatic B cells. *Diabetologia* **30**, 277–291.
8. Pipeleers, D. G. (1992) Heterogeneity in pancreatic B-cell population. *Diabetes* **41**, 777–781.

9. Pipeleers, D., Kiekens, R., Ling, Z., Willikens, A., and Schuit, F. (1994) Physiologic relevance of heterogeneity in pancreatic b cell population. *Diabetologia* **37**, S57–S64.
10. Pipeleers, D. G., Schuit, F. C., in 't Veld, P. A., et al. (1985) Interplay of nutrients and hormones in the regulation of insulin release. *Endocrinology* **117**, 824–833.
11. Pipeleers, D. G., Schuit, F. C., Van Schravendijk, C. F. H., and Van De Winkel, M. (1985) Interplay of nutrients and hormones in the regulation of glucagon release. *Endocrinology* **117**, 817–823.
12. Ling, Z., De Proft, R., and Pipeleers, D. (1993) Chronic exposure of human pancreatic beta-cells to high glucose increases their functional activity but decreases their sensitivity to acute regulation by glucose. *Diabetologia* **36**, A74.
13. Ling, Z. and Pipeleers, D. G. (1996) Prolonged exposure of human beta cells to elevated glucose levels results in sustained cellular activation leading to a loss of glucose regulation. *J. Clin. Invest.* **98**, 2805–2812.
14. Ling, Z., in't Veld, P. A., and Pipeleers, D. G. (1993) Interaction of interleukin-1 with islet B-cells. Distinction between indirect, aspecific cytotoxicity and direct, specific functional suppression. *Diabetes* **42**, 56–65.
15. Ling, Z., Van de Castele, M., Eizirik, D. L., and Pipeleers, D. G. (2000) Interleukin-1beta-induced alteration in a beta-cell phenotype can reduce cellular sensitivity to conditions that cause necrosis but not to cytokine-induced apoptosis. *Diabetes* **49**, 340–345.
16. Hoorens, A., Van de Castele, M., Kloppel, G., and Pipeleers, D. (1996) Glucose promotes survival of rat pancreatic beta cells by activating synthesis of proteins which suppress a constitutive apoptotic program. *J. Clin. Invest.* **98**, 1568–1574.
17. Van de Castele, M., Kefas, B. A., Ling, Z., Heimberg, H., and Pipeleers, D. G. (2002) Specific expression of Bax-omega in pancreatic beta-cells is down-regulated by cytokines before the onset of apoptosis. *Endocrinology* **143**, 320–326.
18. Heimberg, H., Devos, A., Vandercammen, A., Vanschaftingen, E., Pipeleers, D., and Schuit, F. (1993) Heterogeneity in glucose sensitivity among pancreatic beta-cells is correlated to differences in glucose phosphorylation rather than glucose transport. *EMBO J.* **12**, 2873–2879.
19. Heimberg, H., Devos, A., Pipeleers, D., Thorens, B., and Schuit, F. (1995) Differences in glucose transporter gene expression between rat pancreatic alpha-cells and beta-cells are correlated to differences in glucose transport but not in glucose utilization. *J. Biol. Chem.* **270**, 8971–8975.
20. Heimberg, H., Devos, A., Moens, K., et al. (1996) The glucose sensor protein glucokinase is expressed in glucagon-producing alpha-cells. *Proc. Natl. Acad. Sci. USA* **93**, 7036–7041.

Assessment of Insulin Secretion in the Mouse

Marcela Brissova, Wendell E. Nicholson, Masakazu Shiota,
and Alvin C. Powers

1. Introduction

Insulin is synthesized by the β cells of the pancreatic islets as part of a single 110-amino acid precursor, preproinsulin (*see Fig. 1*). Processing is initiated by removal of the amino terminal, 24-amino acid signal sequence (*1*). The resulting 86-amino acid product folds through the formation of three disulfide bridges between Cys⁷–Cys⁷², Cys¹⁹–Cys⁸⁵, and Cys⁷¹–Cys⁷⁶ to produce the prohormone, proinsulin. Insulin and C-peptide are produced when endopeptidases, prohormone convertases 2 and 3 (PC2 and PC3, respectively), cleave proinsulin at two paired basic amino acid sites, Lys⁶⁴–Arg⁶⁵ and Arg³¹–Arg³² (*see Fig. 1*). The basic amino acid pairs are then removed from each site by carboxypeptidase H (*3*). Proinsulin amino acids 66–86 and 1–30 comprise the A- and B- chains, respectively, of mature insulin (*see Fig. 1*). “Split” proinsulin 65–66 and 32–33 are produced when cleavage is incomplete and the basic amino acid pairs are not removed from the cleavage site. “Des” proinsulin 64–65 and 31–32 are produced when cleavage is incomplete and the basic amino acid pairs are removed from the cleavage site (*4*). In the rat, two separate 110-amino acid preproinsulins are transcribed from two nonallelic preproinsulin genes, from which two forms of insulin and C-peptide are subsequently cleaved (*1*) (*see Fig. 1*). The mouse synthesizes two molecular forms of insulin and C-peptide, which are identical to their respective rat counterparts (*5*). The two rodent insulins, designated insulin I and II, are present at a ratio of 1 : 3 in the mouse and 4 : 1 in the rat (insulin I:II) (*6*).

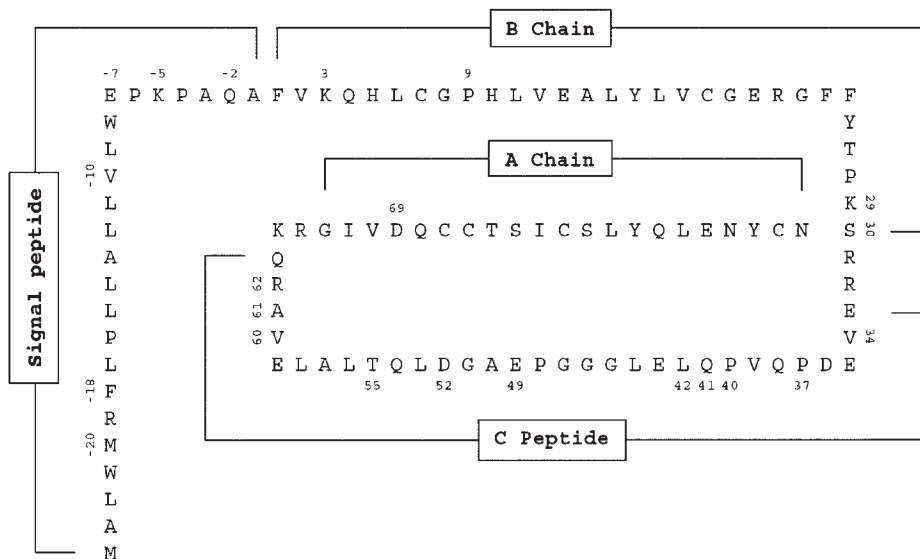

Fig. 1. Amino acid sequence of rat preproinsulin I. The superscripts indicate positions where amino acid differences exist in rat preproinsulin II and/or human preproinsulin relative to rat preproinsulin I. Mature rat insulin I and II are identical except that Ser for Pro⁹ and Met for Lys²⁹ substitutions are incorporated into the B-chain of rat insulin II. Relative to rat insulin I, mature human insulin contains substitutions of Asn, Ser, Thr, and Glu for Lys³, Pro⁹, Ser³⁰ and Asp⁶⁹, respectively. (The rat sequence data are from ref. 1; the human data are from ref. 2).

We describe in this chapter two examples of assessment of insulin secretion in the mouse: (1) measurement of insulin in the portal vein effluent during perfusion of the mouse pancreas *in situ* and (2) determination of plasma insulin in mice undergoing intraperitoneal glucose tolerance testing. Each example includes details of the sample acquisition and subsequent assay of insulin in these samples.

2. Materials

2.1. Reagents

2.1.1. Perfusion of the Mouse Pancreas In Situ

1. Krebs–Ringer bicarbonate buffer (KRB): 4.4 mM KCl, 2.1 mM CaCl₂, 1.5 mM KH₂PO₄, 1.2 mM MgSO₄, 29 mM NaHCO₃, and 116 mM NaCl prepared on the day prior to perfusion.
2. Dextran-70: (cat. no. 17-0280-02, Amersham). Prepare a 3% (w/v) solution in KRB to form KRB–dextran on the day prior to perfusion.
3. Nembutal sodium solution: 50 mg/mL (cat. no. NDC-0074-3778-04, Abbott) diluted 1:10 in 0.9% NaCl. Store up to 1 mo at 48C.

4. Dextrose (cat. no. BP350-1000, Fisher).
5. Arginine·HCl (cat. no. A6757, Sigma Chemical Co., St. Louis, MO).
6. Bovine serum albumin (BSA): Fatty acid free (cat. no. A-6003, Sigma).
7. Sodium chloride: Sterile, 0.9% (w/v) NaCl (cat. no. NDC-0074-4888-10, Abbott Laboratories, North Chicago, IL).

2.1.2. Insulin Immunoassay of Samples Acquired During Perfusion of the Mouse Pancreas In Situ

1. Phosphate buffer (pH 7.4): 0.063 M Na₂HPO₄, 0.013 M C₁₀H₁₄O₈Na₂·2H₂O, and 0.003 M NaN₃ (see **Note 1**). Store at 4°C for up to 1 mo.
2. Bovine serum albumin (BSA): see **Subheading 2.1.1., item 6** (see **Note 2**).
3. Radioimmunoassay (RIA) buffer: 0.5% w/v BSA in phosphate buffer. Store at 4°C for up to 1 wk.
4. Rat insulin reference standard: Prepare by dissolving the contents of one vial of rat insulin (cat. no. 8013, Linco Research, Inc., St. Charles, MO) in 6.25 mL RIA buffer to form 16 ng insulin/mL (standard A). Prepare additional solutions of insulin by diluting standard A with RIA buffer as follows: (1) 1.55 mL A + 1.55 mL RIA buffer = 8 ng/mL, (2) 0.8 mL A + 2.4 mL RIA buffer = 4 ng/mL, (3) 0.4 mL A + 2.8 mL RIA buffer = 2 ng/mL, (4) 0.2 mL A + 3.0 mL RIA buffer = 1 ng/mL, (5) 0.1 mL A + 3.1 mL RIA buffer = 0.5 ng/mL, and (6) 0.05 mL A + 3.15 mL RIA buffer = 0.25 ng/mL. Store 0.25-mL aliquots of each standard solution (12 for each concentration) at -70°C for up to 1 yr.
5. Samples: Store at -70°C until assayed.
6. ¹²⁵I-Insulin: Use according to manufacturer's instructions (see **Note 3**) (cat. no. TIN2, Diagnostic Products Corporation, Los Angeles, CA).

2.1.3. Intraperitoneal Glucose Tolerance Testing in the Mouse

1. Phosphate-buffered saline (PBS): 10 mM Na₂HPO₄, 1.5 mM KH₂PO₄, 2.7 mM KCl, 137 mM NaCl. Store at 4°C.
2. Glucose solution: Prepare 0.1 g/mL dextrose in PBS as needed.
3. Isoflurane, USP (IsoFlo[®], Abbott).

2.1.4. Insulin Immunoassay of Plasma Acquired During Glucose Tolerance Testing in Wild-Type or Transgenic Mice

1. Phosphate buffer (pH 7.4): see **Subheading 2.1.2., item 1**.
2. Triton™ X-100 (cat. no. 161-0407, Bio-Rad Laboratories, Hercules, CA): Prepare a 10% (v/v) solution in phosphate buffer and store at 4°C for up to 6 mo (see **Note 4**).
3. Aprotinin (cat. no. 616398, Calbiochem-Novabiochem, La Jolla, CA): Prepare a 100,000-K.I.U./mL solution by dissolving 500 KU (500,000 K.I.U.) in 5 mL of phosphate buffer. Store 0.25-mL aliquots at -70°C for up to 1 yr.
4. RIA buffer: Prepare by adding 1 mL 10% (v/v) Triton™ X-100 and 0.2 mL (20,000 kIU) aprotinin to 98.8 mL phosphate buffer (see **Notes 4 and 5**). Store at 4°C for up to 1 wk.

5. Rat insulin standard: Prepare by dissolving the contents of one vial of rat insulin (cat. no. 8013, Linco Research, Inc.) in 10 mL RIA buffer to form 10 ng insulin/mL. Store 0.2-mL aliquots at -70°C for up to 1 yr. As needed, dilute 0.1 mL of the 10 ng/mL with 4.9 mL RIA buffer to form 200 pg insulin/mL. Prepare additional solutions of insulin (in RIA buffer) of 100, 50, 20, 10, and 5 pg/mL.
6. Samples: Mouse plasma, stored at -70°C until assayed. As needed, transfer entire sample to a 1.5-mL conical tube (Eppendorf). Record the sample volume. Add enough RIA buffer to form 0.3 mL diluted plasma. Record the dilution factor.
7. Normal guinea pig serum (NPGS): Prepare by dissolving the contents of one vial of lyophilized normal guinea pig serum (cat. no. 7020-25, Linco Research, Inc.) in water as recommended. Store 0.5-mL aliquots at -70°C for up to 2 yr. As needed, dilute 1:50 with RIA buffer to form NGPS buffer (*see Note 6*).
8. Primary antibody (insulin antibody): Prepare by dissolving the contents of one vial of guinea pig anti-rat insulin serum (cat. no. 1013, Linco Research, Inc.) in 10 mL NGPS buffer. Store 0.5 mL aliquots at -70°C for up to 2 yr. As needed, dilute the primary antibody 1:70 in NGPS buffer.
9. Radioactive insulin: Prepare by dissolving the contents of one vial of 125I-human insulin (cat. no. 9011, Linco Research, Inc.) in 10 mL of RIA buffer. Store 1 mL aliquots at -70°C for up to 2 mo. As needed, dilute the 125I-insulin to 5–6000 cpm/0.1 mL with RIA buffer (*see Note 7*).
10. Secondary antibody (antibody to primary antibody): Prepare by dissolving the contents of one vial of goat anti-guinea pig gamma globulin serum (cat. no. 5020-20, Linco Research, Inc.) in water as recommended. Store 0.5-mL aliquots at -70°C for up to 2 yr. As needed, dilute the secondary antibody 1:30 with phosphate buffer.
11. Separation buffer: Prepare by dissolving 2.5 g BSA (cat. no. 60069, ICN Pharmaceuticals, Inc.) and 3.0 g polyethylene glycol 8000 (PEG) (cat. no. BP233-1, Fisher Scientific) in 100 mL phosphate buffer. Stand in ice water until used.

2.1.5. Human Insulin Immunoassay of Plasma Acquired During Glucose Tolerance Testing in Mice Bearing Xenografts of Either Human Islets or Cells Engineered to Secrete Human Insulin

1. See **Subheading 2.1.4., items 1–4.**
2. Human insulin standard: Prepare by dissolving the contents of one vial of human insulin (cat. no. 8014, Linco Research, Inc.) in 10 mL of RIA buffer to form 10 ng insulin/mL. Store 0.2-mL (2-ng) aliquots at -70°C for up to 1 yr. As needed, add in 1.8 mL of RIA buffer to a 0.2-mL (2-ng) aliquot of human insulin to form 1000 pg/mL. Prepare additional solutions of human insulin (in RIA buffer) of 500, 200, 100, 50, 20, 10, and 5 pg/mL.
3. Samples: Mouse plasma, stored at -70°C until assayed. As needed, transfer the entire sample to a 1.5-mL conical tube (Eppendorf). Record the sample volume. Add in enough RIA buffer to form 0.475 mL diluted plasma. Record the dilution factor. Reserve one-half of each diluted sample for use in the mouse plasma insulin RIA, which measures total plasma insulin (human insulin secreted by the grafted cells plus mouse insulin secreted by the host).

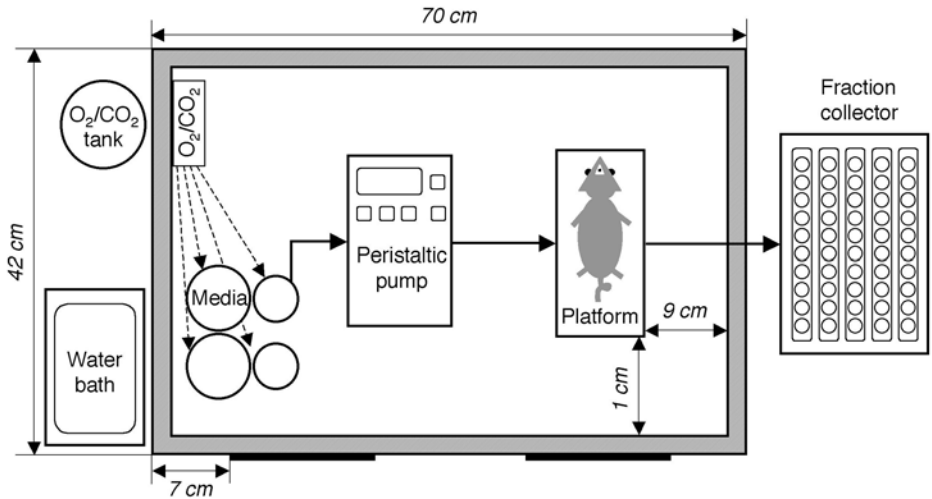

Fig. 2. Diagrammatic representation of the perfusion chamber.

4. See **Subheading 2.1.4., item 7.**
5. Primary antibody (human insulin antibody): Prepare by dissolving the contents of one vial of guinea pig anti-human insulin serum (cat. no. 1014, Linco Research, Inc.) in 10 mL of NGPS buffer. Store 0.5-mL aliquots at -70°C for up to 2 yr. As needed, dilute the primary antibody 1:30 with NGPS-buffer.
6. See **Subheading 2.1.4., items 9–11.**

2.2. Equipment

2.2.1. Perfusion of the Mouse Pancreas In Situ

1. Perfusion chamber (*see Fig. 2*): The chamber was custom-built by Vanderbilt University Medical Center Apparatus Shop of Plexiglas™ (6 cm) construction with dimensions of 70-cm length, 42-cm width, and 38-cm height. There is no bottom panel and operational access is through two, 22×25 -cm holes centered 7 cm in from each end of the front panel and sealed with two, 23×26 -cm Plexiglas™ overlays. The chamber stands on a base that houses the temperature controlling components. The base is of Formica™ covered plywood (1.875 cm) construction with dimensions of 72-cm length, 44-cm width, and 20-cm height. A retractable stainless-steel 12.5×25 -cm platform for animal preparation stands permanently on a pedestal 20 cm above the base from a point located 9 and 1 cm from the right-hand and the front edges of the base, respectively. The platform is fitted with a 2-cm section of 0.5-cm-inner-diameter (I.D.) tubing for drainage.
2. Peristaltic pump: Ismatech model ISM758 (Cole Parmer, Vernon Hills, IL).
3. Fraction collector: Fitted for 12-mm test tubes (cat. no. 11-187-37, Fisher Scientific, Pittsburgh, PA).

4. Test tubes: Polypropylene, 12 × 75 mm (cat. no. 8563, Stockwell Scientific, Scottsdale, AZ).
5. 95% O₂/5% CO₂: Tank fitted with flow-regulator model MOF15-4A (Victor Medical Products, Denton, TX).
6. Stopcock: Three-way (cat. no. P-06225-20, Cole Parmer).
7. Water bath (cat. no. 15-462-10, Fisher).
8. Glass-reinforced tape: 18.75 mm wide (cat. no. 9088-H50, A. H. Thomas, Swedesboro, NJ).
9. Double-sided foam tape: 18.75 mm wide and 1.56 mm thick (cat. no. 4016NA, 3M Bonding Systems Division, St. Paul, MN).
10. Support rod: 31-cm Section (cat. no. 14-666-10G, Fisher).
11. Stopcock: Luer connections (cat. no. 30600-11, Cole Parmer).
12. L-Shaped connectors: 6 mm (cat. no. 15-315-29B, Fisher).
13. T-Shaped connectors: 6 mm (cat. no. 15-315-26B, Fisher).
14. Tygon™ tubing: 4.8 mm I.D. (cat. no. 14-169-1G, Fisher).
15. Tygon™ tubing: 1.6 mm I.D. (cat. no. 14-169-1B, Fisher).
16. Pipetting needle: 18 gauge × 15 cm (cat. no. 8957, Thomas).
17. Hypodermic needle: 18 g × 3.75 cm, disposable (cat. no. 8956-E84, Thomas).
18. Plexiglas™: 1.27 cm-thick, 5 × 10-cm section (locally obtained).
19. Luer-to-tubing connector: Female (cat. no. BB-329-1/16, Scientific Commodities, Inc., Lake Havasu City, AZ).
20. Luer-to-tubing connector: Male (cat. no. BB-330-1/16, Scientific Commodities).
21. Manifold pump tubing: 2.8 mm outer diameter (O.D.), 1.14 mm I.D. (cat. no. 14-190-104, Fisher).
22. Manifold pump tubing: 2.4 mm O.D., 0.51 mm I.D. (cat. no. 14-190-109, Fisher).
23. Capillary tubing: Polyethylene, 1.8 mm O.D., 0.8 mm I.D. (cat. no. 19-0040-01, Amersham Biosciences, Piscataway, NJ).
24. Capillary tubing: Silicone, 0.94 mm O.D., 0.51 mm I.D. (cat. no. 60985-702, VWR Scientific).
25. Tygon™ tubing: 0.75 mm O.D., 0.25 mm I.D. (cat. no. 63018-022, VWR).
26. Forceps: Straight, hemostat, 127 mm, serves as a flaring tool (cat. no. 3865-T25, Thomas).
27. Hypodermic needle: 27 gauge × 31.25 mm (cat. no. CX23535F, A. Daiger and Company, Inc., Lincolnshire, IL).
28. Media bottles with caps: 100 mL, 500 mL, 1000 mL (cat. no. 06-414-1A, 06-414-1C, 06-414-1D, respectively, Fisher).
29. Media bottles caps: Additional caps are drilled with a 2.3-mm hole through which the O₂/CO₂ mixture is delivered into the bottle and 4.3 mm hole through which medium is pumped from the bottle (cat. no. 06-414-2A, Fisher).
30. Bottle-top filters: 45- μ m Pore size, 150- and 500-mL capacity (cat. no. 09-761-57 and 09-761-53, Fisher).
31. One milliliter syringe (cat. no. 309623, Becton Dickinson).
32. Surgical tools: These tools are designed for microdissection and include forceps (cat. no. RS-8122), scissors (cat. no. RS-5912), extra delicate straight forceps (cat.

no. RS-5132), extra delicate, slightly curved forceps (cat. no. RS-5136), spring scissors—curved and sharp (cat. no. RS-5603) (all from Roboz Surgical Instrument Co., Inc., Rockville, MD).

33. Surgical silk 6-0 (cat. no. 104-S, Braintree Scientific, Inc., Braintree, MA).

34. Saran Wrap™.

2.2.2. Insulin Immunoassay of Samples Acquired During Perfusion of the Mouse Pancreas In Situ

1. Test-tube racks: Wire, epoxy-coated, 6 × 15-place (cat. no. 60916-717, VWR Scientific Products).
2. Test tubes (plain): see **Subheading 2.2.1., item 1.**
3. Test tubes (antibody-coated): Polypropylene, 12 × 75 mm, coated with guinea pig anti-porcine insulin serum (cat. no. 07-260110, ICN Pharmaceuticals, Inc., Costa Mesa, CA).
4. Pipetters: 20-, 200-, 1000-, and 5000- μ L capacity with appropriate tips.
5. Microtube racks: Acrylic, 1.5- to 2.0-mL tube size (cat. no. 146140, Research Products International Corp., Mt. Prospect, IL).
6. Pipet: Repeating, calibrated to deliver 0.9 mL.
7. Bags: Polyethylene, clear, thickness of 0.05 mm, dimensions of 12.5 × 8.75 × 37.5 cm.
8. Blotting surface: Absorbent bench pads, 58 × 91 cm (cat. no. 56616-026, VWR).
9. Test-tube racks: Foam, 5 × 10 place (cat. no. 05-664-15A, Fisher Scientific).
10. Gamma counter: APEX™ Automatic Gamma Counter model 280198 (ICN Micromedic System, Huntsville, AL) calibrated for 125 I and interfaced with a computer running data acquisition and analysis software.

2.2.3. Intraperitoneal Glucose Tolerance Testing in the Mouse

1. Ten milliliter syringe.
2. Fifty milliliter sterile centrifuge tubes (cat. no. 14-959-49A, Fisher).
3. Syringe filter (0.2- μ m pore size) (cat. no. 09-730-218, Fisher).
4. Laboratory balance.
5. One milliliter syringe fitted with needle (cat. no. 309623, Becton Dickinson).
6. Gauze pads: Cheesecloth mini-wipes, 10 × 10 cm (cat. no. 21910-107, VWR).
7. Petri dish: Polystyrene, 6 cm.
8. Parafilm.
9. Pasteur pipet with the bulb.
10. Anesthesia chamber: Surgical dressing jar, glass (cat. no. 11-835B, Fisher).
11. Glucometer (Accu-Check Advantage®, Roche-Boehringer Mannheim, Indianapolis, IN) and glucose detection strips.
12. Heparinized capillary tubes (cat. no. 02-668-10, Fisher).
13. Microtube racks: Acrylic, 0.5-mL tube size (cat. no. 146154, Research Products).
14. Two sets of prelabeled color-coded 0.5-mL Eppendorf tubes.
15. Ice.
16. Pipetters: 20- and 200- μ L capacity.

17. Pipet tips: Standard type 200- μ L capacity, and gel-loading type 200- μ L capacity.
18. Refrigerated benchtop microcentrifuge: Biofuge Fresco (Kendro Laboratory Products, Newton, CT).

2.2.4. Insulin Immunoassay of Plasma Acquired During Glucose Tolerance Testing in Wild-Type or Transgenic Mice

1. Test-tube racks: see **Subheading 2.2.2., item 1.**
2. Test-tube racks: Wire, epoxy-coated, 6 \times 12 place (cat. no. 60916-772, VWR Scientific Products).
3. Test-tubes (plain): see **Subheading 2.2.1., item 4.**
4. Pipettors: 20-, 200-, and 1000- μ L capacity with appropriate tips.
5. Pipetter: Repeating, calibrated to deliver 0.1 mL.
6. Polyethylene bags: see **Subheading 2.2.2., item 7.**
7. Pipetter: Repeating, calibrated to deliver 1.6 mL.
8. Centrifuge: Refrigerated (Model RC-3C, Kendro Laboratory Products), calibrated to deliver 6000g when equipped with a H-6000A-6 swinging bucket rotor fitted with 33-place tube adapters (cat. no. 00857). Each adapter has a 0.5 \times 2.0-cm center spindle that facilitates insertion into and removal from the swinging bucket.
9. Gauze: Wire, nickel-chromium, 12.7 \times 12.7-cm section (cat. no. 15-585B, Fisher). Enlarge the center mesh to about 0.75 cm with a screwdriver.
10. Paper towels (rolled). As needed, stack three sheets of toweling, fold in half then quarters to form a 12-ply, 12 \times 14-cm pad for blotting the assay tubes. Cut a 1-cm hole in the center of the pad, thereby permitting the pad to come into full contact with the tops of the tubes and facilitate blotting.
11. Gamma counter: see **Subheading 2.2.2., item 10.**

2.2.5. Human Insulin Immunoassay of Plasma Acquired During Glucose Tolerance Testing in Mice Bearing Xenografts of Either Human Islets or Cells Engineered to Secrete Human Insulin

Same items as in **Subheading 2.2.4.**

3. Methods

3.1. Perfusion of the Mouse Pancreas In Situ

Diagrams of the perfusion chamber and mouse surgery are shown in **Fig. 2** and **Fig. 3**, respectively.

3.1.1. O₂/CO₂ Manifold Assembly

1. Attach a three-way stopcock to the O₂/CO₂ flow regulator with a 5-cm section of 4.8-mm-I.D. tubing. Connect three T-shaped connectors end-to-end with 5-cm sections of 4.8-mm-I.D. tubing. Connect one L-shaped connector to one free end of the T's. Connect approx 2 m of 4.8-mm-I.D. tubing to the remaining free end of the T's for later attachment to stopcock-flow regulator assembly.

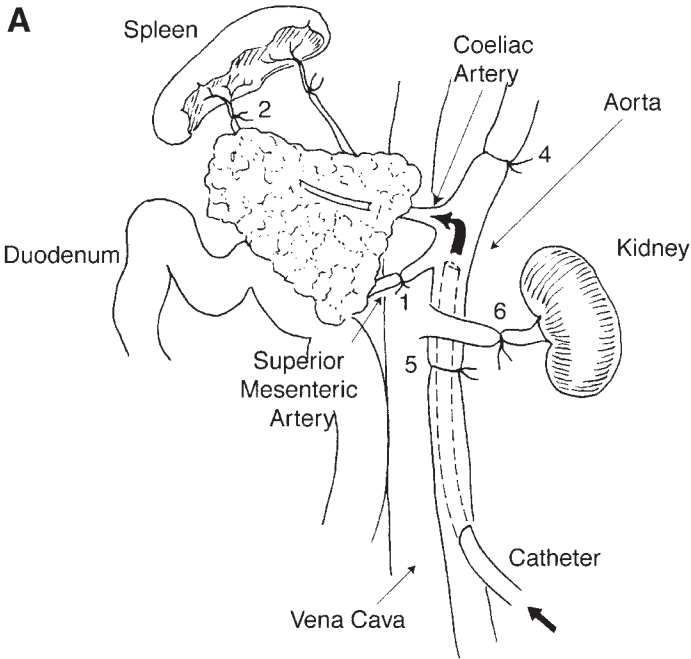

M.M.P.

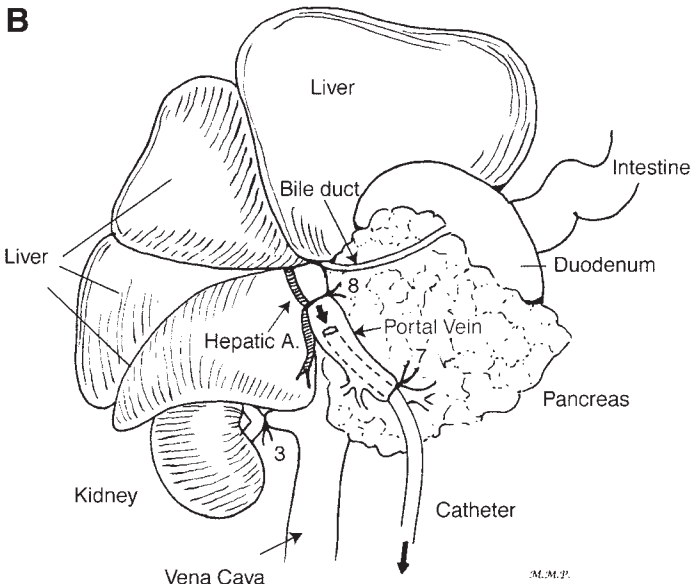

M.M.P.

Fig. 3. Perfusion of mouse pancreas *in situ*. (A, B) Diagrammatic representation of the blood vessel ligation in the mouse.

2. Attach a 5-cm section of 4.8-mm-I.D. tubing to each of three remaining T's and 1 L point. Remove the flange from the female point located opposite the male point on four three-way plastic stopcocks. Attach a stopcock, through its modified point, to each of the four free ends of the 5-cm sections of tubing.
3. Fit each end of four 30-cm sections of 1.6-mm-I.D. tubing with a male or female Luer-to-tubing connector. Attach the female Luer to the male point on each of the four stopcocks. Attach an 18 gauge \times 15-cm pipetting needle to each male Luer-to-tubing connector.
4. Align a 30-cm section of support rod along the top of the manifold so that one end of the rod coincides with the closed end of the manifold. Secure the manifold to the support rod with glass-reinforced tape. Use a support stand to suspend the O₂/CO₂ manifold approx 30 cm above the water bath.
5. Prepare an identical O₂/CO₂ manifold, except use four blunted (90° cut) 18 gauge \times 3.75-cm disposable hypodermic needles in place of the longer pipetting needles. Secure a 30-cm section of the support rod to the manifold, as before. Align the free end of the support rod along the 1.27-cm side of a 1.27 \times 5 \times 10-cm section of Plexiglas™ and secure with glass-reinforced tape. Using double-sided tape, attach the section of Plexiglas™ to the inside rear upper left corner of the perfusion chamber with the manifold directed toward the front of the chamber.

3.1.2. Perfusion Catheter Assembly

1. Attach two male and one female Luer-to-tubing connectors to a three-way stopcock and fit each connector with a 1.5-cm section of 1.14-mm-I.D tubing. Insert a 20-cm section of 1.8-mm-O.D./0.8-mm-I.D. tubing into the 1.14-mm-I.D tubing on each male Luer-to-tubing connector.
2. Partially bevel and polish two 15-cm pipetting needles. In addition, remove the hubs (90° cut) and polish the shaft. Attach the needle shafts (at the former hub end) to the free ends of the 0.8-mm-I.D. tubing using 1.5-cm sections of 1.14-mm-I.D tubing as connectors. The needle serves to guide the capillary tubing into the media bottles.
3. Insert a 40-cm section of the 1.8-mm-O.D. tubing into the 1.14-mm-I.D tubing on the female Luer-to-tubing connector. Attach a 3-cm section of double-sided tape to the rear of the stopcock assembly. Mount the assembly on the inside wall of the perfusion chamber above the area designated for media bottles.
4. Install 1.14-mm-I.D manifold pump tubing into the cartridge of the peristaltic pump and connect the inlet side to the free end of the 1.8-mm-O.D. tubing coming from the stopcock assembly. This step completes the assembly of the perfusion catheter leading from the media reservoir to the inlet of the peristaltic pump.
5. Connect the outlet of the manifold pump tubing to a female Luer-to-tubing connector. Flare each end of a 10-cm section of 0.51-mm-I.D. manifold pump tubing. Insert a male Luer-to-tubing connector into one end and a 65-cm section of 0.75-mm-O.D/0.25-cm-I.D. tubing into the other end. Connect the male Luer-to-tubing connector to the female Luer-to-tubing connector exiting the pump. This Luer-to-Luer connection is helpful when removing air and blockages from the tubing.

6. Partially blunt (90° cut removing approx 50% of the bevel) a 27 gauge \times 31.25-mm hypodermic needle. Polish the end to a smooth and curved point. Remove the hub (90° cut) and polish the shaft. Insert the former hub end of the needle shaft into the free end of the 0.25-mm-I.D. tubing. This step completes the assembly of the perfusion catheter leading from the outlet of the peristaltic pump to the aorta of the mouse.
7. Cut a 45-cm-long piece of 0.51-mm-I.D/0.94-mm-O.D. tubing at 45° on one end. Leave the angled end of tubing on the platform. Guide the other end through a small hole in the center of right-hand wall of the chamber (approx 0.4 mm in diameter) and mount it onto a fraction collector.

3.1.3. Preparation of Perfusion Media

1. On the day before perfusion, dissolve the desired amount of glucose (or any given stimulus such as arginine) in KRB–dextran and filter into fresh media bottles. Store at 4°C.
2. On the day of perfusion, place the media bottles fitted with the predrilled caps in the water bath, oxygenate the media by bubbling (0.5 mL/min) for 20 min with the 95% O₂/5% CO₂ mixture while the media equilibrate to 37°C.
3. After the media are oxygenated, add BSA (at a final concentration of 1% w/v) and dissolve by intermittent swirling to form perfusion media while maintaining an O₂/CO₂ atmosphere in the bottles (*see Note 8*). Attach blunted 18 gauge \times 3.75-cm needles instead of 18 gauge \times 15-cm needles to the manifold to prevent excess foaming.
4. Transfer up to four media preparations into the perfusion chamber and attach each to the O₂/CO₂ manifold using the blunted 18 gauge \times 3.75-cm needles. Insert the two 18 gauge \times 15-cm needle–capillary tubing leads from the stopcock of the catheter assembly into the first two media preparations to be tested (*see Note 9*). Maintain the O₂/CO₂ atmosphere in the media bottles throughout the experiment.
5. Prime (1.75 mL/min) and run the system with the first test preparation for 5 min after the tubing is free of air bubbles. Switch to the basal medium, prime, and run the perfusion system for 15 min after all the air is expelled from the tubing.

3.1.4. Mouse Surgery and Perfusate Collection (*see Fig. 3*)

1. Anesthetize the mouse with an intraperitoneal injection of 80 mg Nembutal/kg body weight.
2. Place the mouse on the retractable platform overlaid with a 20 \times 30-cm section of Saran Wrap™ and begin the surgery by opening an abdominal cavity. After a mid-line abdominal incision of the skin, the abdomen is incised from the pubic symphysis to the xiphoid process.
3. Ligate the superior mesenteric artery (**Fig. 3A**, ligature 1), splenic artery (**Fig. 3A**, ligature 2), and right renal arteries (**Fig. 3B**, ligature 3), using extra-delicate straight and slightly curved forceps and surgical suture.
4. Place two loose ligatures around the aorta, just below the diaphragm (**Fig. 3A**, ligature 4) and just below the level of the left renal artery (**Fig. 3A**, ligature 5). Then

place the loose ligature around the left renal artery (**Fig. 3A**, ligature 6). Finally, place two loose ligatures around the hepatic portal vein; the first one is approximately 1.5 cm below the liver (**Fig. 3B**, ligature 7) and the second ligature is just below the liver (**Fig. 3B**, ligature 8).

5. Tie the ligature previously placed around the aorta below the diaphragm (**Fig. 3A**, ligature 4). Immediately cannulate the aorta with the 27-gauge needle held with forceps. Push the needle into the celiac trunk. Tie the second ligature previously placed around the aorta to fix the needle (**Fig. 3A**, ligature 5).
6. Using spring scissors cut the portal vein and cannulate it with the beveled end of the 45-cm section of silicone tubing (0.51 mm I.D./0.94 mm O.D.). Tie the ligature previously placed around the portal vein (1.5 cm below the liver) to fix the catheter (**Fig. 3B**, ligature 7).
7. Tie the ligatures previously placed around the portal vein and hepatic artery just below the liver (**Fig. 3B**, ligature 8) and tie the ligature around the left renal artery (**Fig. 3A**, ligature 6).
8. Immediately kill the animal by cutting the diaphragm and heart. Wrap the body with the Saran Wrap™ to maintain the pancreas in a moist and 37°C atmosphere.
9. Adjust the flow rate. The ideal range for pancreatic perfusion is from 0.5 to 0.8 mL/min (7, 8).
10. Perfuse the pancreas with basal glucose medium for 30 min before collecting the timed fractions of the pancreatic effluent (see **Note 10**).
11. Immediately freeze the fractions of the perfusate at -20°C. For long-term storage use -70°C.

3.2. Mouse Insulin Immunoassay of Samples Acquired During Perfusion of the Mouse Pancreas In Situ

An example of insulin secretion data from the *in situ*-perfused mouse pancreas is shown in **Fig. 4**.

1. Label duplicate plain tubes in the sequence: [T] (total counts) and [N] (nonspecific binding).
2. Label duplicate antibody-coated tubes in the sequence: [R] (reference or maximum binding), [4-10] (reserved for standard insulin), and [11-*n*] (*n*-number of samples). Put tubes in wire racks.
3. Pipet 0.1 mL RIA buffer into tubes [T-R].
4. Pipet 0.1 mL each insulin standard solution into tubes [4-10] beginning with 0.25 ng/mL into tube [4].
5. Pipet 0.1 mL each sample (neat or appropriately diluted in RIA buffer) into the remaining tubes beginning with sample 1 into tube [11].
6. Add 0.9 mL ¹²⁵I-insulin (repeating pipet) to all tubes. Mix and seal each rack of tubes in a polyethylene bag (see **Note 11**).
7. Incubate the tubes for 24 h at 4°C.
8. Transfer the tubes (except [T]) to the foam racks. Without removing the tubes from the foam racks, decant the non-antibody-bound counts, leaving the antibody-bound

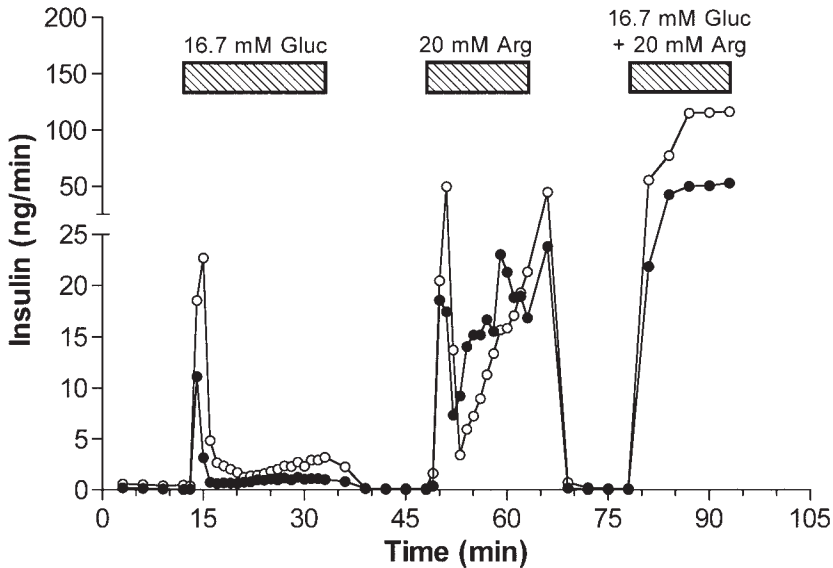

Fig. 4. Insulin secretory response of the *in situ*-perfused pancreas. Insulin secretion from the pancreas of a PDX-1 heterozygote mouse (filled circles) and its wild-type littermate (open circles) was analyzed in response to glucose and arginine. The integrated response to 16.7 mM glucose was 81 ng insulin in the PDX-1 (+/+) mouse versus 31 ng insulin in the PDX-1 (+/-) mouse. The integrated response to 20 mM arginine in the presence of 5.6 mM glucose was 381 ng insulin in the PDX-1 (+/+) mouse versus 317 ng insulin in the PDX-1 (+/-) mouse. The integrated response to 16.7 mM glucose + 20 mM arginine was 1264 ng insulin in the PDX-1 (+/+) mouse versus 575 ng insulin in the PDX-1 (+/-) mouse.

counts on the walls of the tubes and blot the tubes on the absorbent surface (*see Note 12*).

9. Transfer the tubes to appropriate racks for counting in a gamma counter (5 min/tube) (*see Notes 13 and 14*).

3.3. Intraperitoneal Glucose Tolerance Testing in the Mouse

1. Fast the mice for 12–15 h prior to glucose tolerance testing by transferring them into clean cages with bedding and water supply only.
2. Filter glucose solution into a 50-mL tube using a 0.2- μ m filter attached to a 10-mL syringe and keep the solution at room temperature.
3. Weigh the mice and record their body weight.
4. Calculate the volume of glucose solution required for intraperitoneal injection so that each animal receives 2 g of glucose per kilogram of body weight.

5. Drill several 3-mm holes in a Petri dish lid to permit the anesthetic to fill the anesthesia chamber. Place gauze square into the Petri dish, seal it with parafilm, and put on the bottom of the chamber.
6. Apply approx 4 mL of Isoflurane onto the gauze in the Petri dish using a Pasteur pipet and allow a few minutes to saturate the chamber with anesthetic.
7. Anesthetize the mouse (*see Note 15*). Observe the mouse carefully, as it is easy to overanesthetize.
8. Prior to glucose injection, draw about 70 μL of blood from the retroorbital sinus using a heparin-coated capillary tube and immediately expel its contents into an ice-cold 0.5-mL Eppendorf tube (*see Note 16*). Keep tube on ice.
9. Apply 9 μL of the blood sample (200- μL tip attached to a 20- μL pipetter) onto a glucose detection strip inserted into the glucometer and record the glucose concentration.
10. Spin the remainder of the blood sample for 4 min at 12,000 rpm at 4°C. Carefully transfer the plasma into a fresh ice-cold 0.5-mL Eppendorf tube using a 200- μL gel-loading tip attached to a 200- μL pipetter.
11. Immediately freeze the plasma sample at -20°C . For long-term storage, keep at -70°C .
12. Inject the mouse intraperitoneally with the calculated volume of glucose solution. For example, a 25-g mouse would receive 500 μL of the glucose solution by intraperitoneal injection. Collect blood samples at 15, 30, 60, 90, and 120 min after glucose administration by repeating **steps 7–11** (*see Note 17*).

3.4. Mouse Insulin Immunoassay of Plasma Acquired During Glucose Tolerance Testing in Wild-Type or Transgenic Mice

An example of insulin secretion during glucose tolerance testing in mice is shown in **Fig. 5**.

1. Label duplicate plain 12 \times 75-mm tubes in the sequence: [T], [N], [R], and [4–n].
2. Pipet 0.1 mL RIA buffer into tubes [N] and [R]. Pipet 0.1 mL of each standard solution into tubes [4–9], beginning with 5 pg/mL into tube [4].
3. Pipet 0.1 mL each diluted plasma sample into the remaining tubes, beginning with the first sample into tube [10].
4. Add 0.1 mL diluted primary antibody (repeating pipet) to all tubes except [T] and [N]. Add 0.1 mL NGPS buffer to tubes [N]. Mix, seal the tubes in the rack as in the solid phase assay and incubate for 72 h at 4°C.
5. Add 0.1 mL of diluted ^{125}I -insulin (repeating pipet) to all tubes, reseal the bags, and continue the incubation for 24 h at 4°C.
6. Add 0.1 mL diluted secondary antibody to all tubes except [T]. Mix, reseal, and incubate for 3 h at 4°C.
7. Add 1.6 mL ice-cold separation buffer (repeating pipet) to all tubes except [T]. Add separation buffer to only those tubes that can be centrifuged immediately. Keep the remainder covered and at 4°C. Without mixing and without delay, transfer the tubes to the precooled centrifuge adapters and centrifuge for 30 min at 6000g at 4°C.

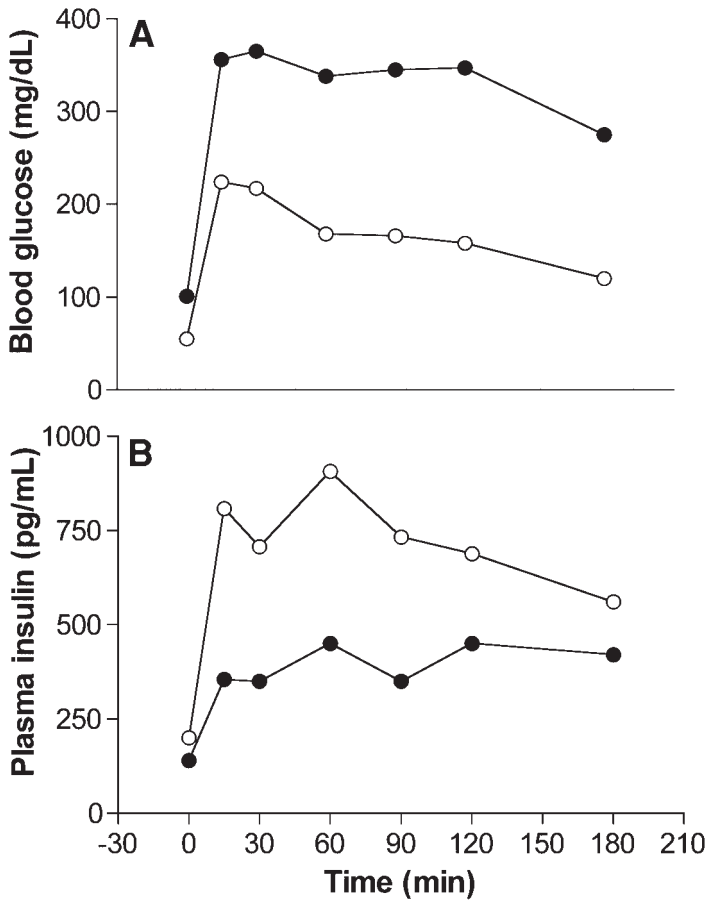

Fig. 5. Impaired glucose tolerance in mice heterozygous for PDX-1. Fasted mice received glucose by intraperitoneal injection (2 g/kg body weight). Blood samples collected from retro-orbital bleeds were immediately analyzed for glucose. Plasma was collected from the remainder of the blood sample for insulin RIA. Open circles: wild-type mouse; filled circles: PDX-1 heterozygote mouse.

- Without delay and without removing the tubes from the centrifuge adapters, remove the adapters from the swinging buckets, place the wire gauze over the tubes, grip the wire-adaptor assembly with both hands (fingers on the outer edge of the wire and thumbs underneath the adapter), and invert the assembly for 10 s. Return the assembly to the horizontal position, replace the wire with the paper toweling pad, grip the pad-adaptor assembly as before, guide the spindle of the first adapter into the 27-hole of the 6 × 12-place test tube rack (spindle of the second adapter into the 34-hole), allowing the weight of the adapter to settle the tubes onto the pad for blotting (see Note 18).

9. After blotting for 1 min, transfer the tubes to gamma counter racks for counting (5 min/tube) (see **Notes 19-21**).

3.5. Human Insulin Immunoassay of Plasma Acquired During Glucose Tolerance Testing in Mice Bearing Xenografts of Either Human Islets or Cells Engineered to Secrete Human Insulin

An example of insulin secretion during glucose tolerance testing in mice bearing human islet xenografts is shown in **Fig. 6**.

1. Label duplicate plain 12 × 75-mm tubes in the sequence: [T], [N], [R], and [4-n].
2. Pipet 0.1 mL RIA buffer into tubes [N] and [R]. Pipet 0.1 mL of each human insulin standard into tubes [4-11], beginning with 5 pg/mL into tube [4].
3. Pipet 0.1 mL each diluted plasma sample into remaining tubes, beginning with the first sample into tube [12].
4. Add 0.1 mL primary antibody (repeating pipet) to all tubes except [T] and [N]. Mix, seal the tubes in the rack as in the mouse plasma insulin RIA, and incubate for 72 h at 4°C (see **Notes 22-24**).
5. Follow steps 5-9 from **Subheading 3.4**. (see **Note 25**).

4. Notes

1. Phosphate buffer, with disodium EDTA as its acidic component, is widely used in RIA procedures. EDTA inhibits divalent cation-dependent enzymes that might degrade insulin during long incubations. Furthermore, it inactivates complement that might inhibit antigen-antibody binding.
2. The fatty-acid-free BSA, which is also partially purified as the free fatty acids are removed by charcoal extraction, prevents nonspecific surface binding of insulin and antibody. We found this particular BSA to have wide application in RIA procedures, presumably because the charcoal extraction removes endogenous ligands and/or impurities.
3. ¹²⁵I-Human insulin (cat. no. 07-260121, ICN Pharmaceuticals, Inc.) can also be used.
4. Triton™ X-100 is a very viscous liquid and is best handled by preparing an intermediate concentrate of 10% (v/v). The presence of the nonionic detergent in the RIA buffer reduces the nonspecifically bound labeled insulin fraction [N] to <1% of the total labeled insulin [T], without significantly reducing the antibody-bound fraction of labeled insulin [R]. With Triton X-100 in the RIA buffer, the ratio [R] : [N] increases to 28 : 1 from 7 : 1 in the BSA-RIA buffer. However, Triton X-100 should not be added to any RIA buffer without first comparing [R]:[N] ratios, in the presence of graded amounts of the detergent, to the [R]:[N] ratio obtained with protein-supplemented RIA buffer.
5. Aprotinin, a competitive inhibitor of proteolytic activity, helps to preserve insulin during long incubations.

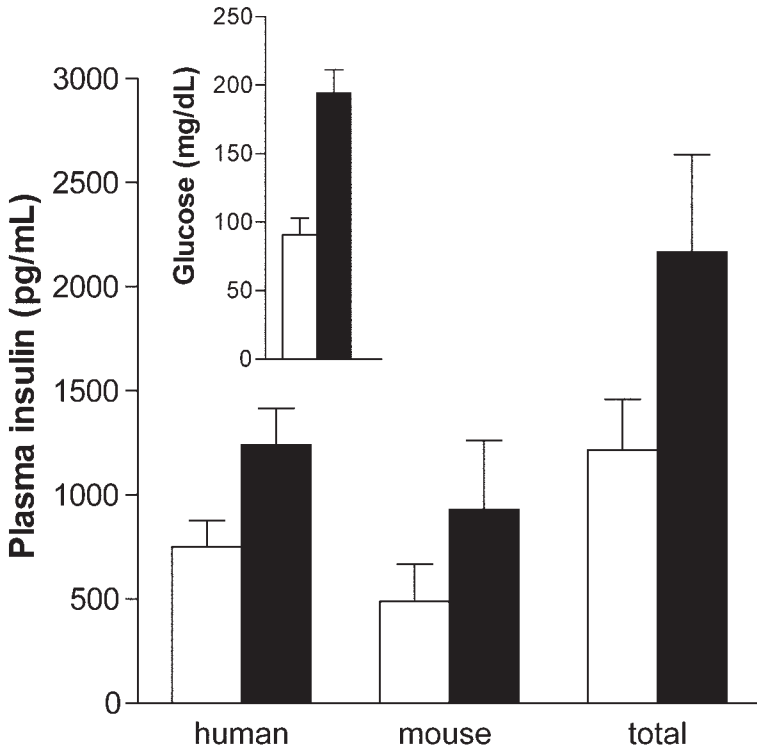

Fig. 6. Plasma insulin levels in a NOD-SCID mouse bearing a human islet xenograft under the renal capsule. Glucose, 2 g/kg body weight, was given intraperitoneally on nine occasions, at 6- to 21-d intervals, during a 90-d period. Blood was collected from the saphenous vein without anesthesia before (open bars) and 30 min after glucose administration (solid bars) for the measurement of total and human plasma insulin by the mouse plasma insulin RIA and the human insulin RIA, respectively. The level of endogenous mouse plasma insulin was derived by subtracting the amount of human insulin from the total amount of insulin found in the sample. Each bar represents the mean \pm S.E.M. of the nine insulin levels. (The data are courtesy of Michael J. Fowler, Vanderbilt University Medical Center, Nashville, TN).

6. Initially, NGPS serves as a protein carrier for the primary insulin antibody. Later, the gamma globulin component of NGPS and the primary insulin antibody coreact with the secondary antibody to guinea pig gamma globulin to form a precipitable complex.
7. The dilution factor of the ^{125}I -insulin preparation should be adjusted initially to deliver 5000–6000 cpm per 0.1 mL and readjusted as the isotope decays.

8. Some batches of BSA cause the pancreas to swell during perfusion resulting in a dramatic drop in the flow rate. We recommend testing BSA quality in the perfusion system using wild-type mice before attempting pancreatic perfusion of more valuable experimental animals.
9. A linear glucose gradient is frequently used to test pancreatic insulin secretion in the transgenic animals (9). This can be accomplished by using Amersham's Gradient Mixer GM-1 (cat. no. 19-0495-01, Amersham Biosciences) in the pancreatic perfusion system.
10. When the pancreas is being perfused initially with the basal medium, the effluent is usually contaminated with blood during the first 15 min but clears up completely by 30 min.
11. Sealing the rack of tubes in a polyethylene bag to prevent evaporation during long incubations is an alternative to capping each tube.
12. Transferring the tubes to foam racks for decanting and blotting is an alternative to either decanting the tubes while they stand in the incubation racks or decanting or aspirating individual tubes.
13. In this solid-phase RIA, the rat insulin standard is indistinguishable from the First International Standard for Human Insulin, coded 83/500 and established in 1986 by The World Health Organization's Expert Committee on Biological Standardization. The ED₁₀, ED₅₀, and ED₉₀, the concentration of either rat or human insulin reference standard required to reduce reference binding by 10%, 50%, and 90%, was 0.22, 2.5, and 29 ng/mL, respectively.
14. Immunoassay is the method of choice for the measurement of insulin from any source in any species. During the past 4.5 decades, numerous commercial immunoassays for insulin have been developed. Especially plentiful are the heterospecies-specific competitive immunoassays employing antibodies made to either human, porcine, or bovine insulin, which tend to recognize the hormone from several species. Competitive immunoassays are those in which a fixed amount of labeled insulin and a variable amount of reference standard or sample insulin are allowed to compete for a limited number of insulin antibody-binding sites. The amount of antibody-bound labeled insulin, found at the end of a specific interval, is inversely proportional to the amount of unlabeled insulin present. The high degree of sequence homology between these vertebrate insulins, 2–4 amino acid substitutions out of 51, suggests that some of the established heterospecies-specific large-animal insulin immunoassays might recognize mouse insulin to the extent that they could be used to measure the mouse hormone. When the concentration of mouse insulin is expected to be >0.2 ng/mL (3.4×10^{-11} M) and sample size >0.25 mL (e.g., insulin secretion by the perfused mouse pancreas *in situ* or by isolated mouse islets and β -cell lines during perfusion or static culture), the antibody component of a pre-existing large-animal competitive immunoassay, with an affinity for mouse or rat insulin of at least 2×10^{10} L/mol, can become a basis of a customized immunoassay for the mouse hormone. To study mouse insulin released under these conditions, we selected the antibody component from a commercial human insulin solid-phase RIA kit with a K_a of 2.3×10^{10} L/mol ($K_d = 4.3 \times 10^{-11}$ mol/L or 0.25

ng/mL) and 85% crossreactivity with rat insulin as the basis for our customized mouse insulin RIA. Currently, immunoassays for mouse or rat insulin reflect an estimate of the sum of insulin I and II in the sample plus any proinsulin or partially hydrolyzed proinsulin detected by the assay. C-Peptide is not detected by insulin immunoassays.

15. An alternative way of performing glucose tolerance testing is to use a conscious mouse. In this case, the mouse can be restrained in a 50-mL Falcon centrifuge tube and blood is sampled from the saphenous vein using a Microvette system (cat. no. 16-443-300, Sarstedt, Newton, NC).
16. Extra precautions should be taken when handling blood samples. Blood from the heparinized capillary tube should be expelled immediately into a chilled Eppendorf tube to facilitate anticoagulation and minimize hemolysis. Red blood cells contain an insulin-degrading enzyme or insulinase that can cleave insulin molecules and have a devastating impact on insulin measurement by immunoassay (*10,11*). Sapin et al. showed that insulin degradation in hemolyzed plasma could be prevented much more effectively by cold storage of samples and 4°C incubations (during insulin assay) than by using the chelating agent EDTA (10 mM/L) (*10*). If samples cannot be handled on ice, these authors recommended the use of 1 mM/L *p*-chloromercuriphenyl sulfonic acid (CPMS) inhibitor to protect insulin from degradation because of hemolysis (*10*).
17. With the help of the second person, it is possible to test up to 12 mice in one series by dividing them into two groups and injecting them with glucose in 2-min intervals.
18. Effective decanting and blotting of the assay tubes is facilitated by the handling, volume, and composition of the separation buffer. The immediate ice-cold, 30-min, 6000g spin helps to solidify the precipitate. The volume of buffer dilutes the counts and renders any hanging drop(s) less radioactive. The BSA binds any excess detergent, thereby reducing pellet slippage. A less pure and more economical preparation of BSA is recommended for this purpose, as it is in contact with the reactants for a short period of time. The PEG enhances precipitation of the secondary antibody–first antibody complex as PEG, in higher concentrations, can completely precipitate gamma globulin.
19. When the concentration of mouse insulin is expected to be as low as 60 pg/mL (10^{-11} M) and sample size as small as 0.01 mL (e.g., plasma insulin in wild-type or transgenic mice undergoing glucose tolerance testing), the antibody component of a preexisting heterospecies-specific competitive immunoassay, with an affinity for mouse or rat insulin of approx 10^{11} L/mol, can become the basis of an immunoassay with the required sensitivity to measure the hormone in mouse plasma. To study mouse plasma insulin, we selected a rat insulin antibody with a K_d of 5×10^{10} L/mol ($K_d = 2 \times 10^{-11}$ mol/L or 115 pg/mL) and 100% crossreactivity with mouse, human, porcine, hamster, or sheep insulin, as the basis for our mouse plasma insulin RIA.
20. Delayed addition of the labeled antigen, shown in some instances to improve competitive immunoassay sensitivity, results in a more than 10-fold increase in sensitivity as the ED_{10} , ED_{50} , and ED_{90} , of this insulin RIA shifted from 95, 700, and

5400 (manufacturer's data) to 7.5, 40, and 200 pg insulin/mL, respectively. This converts to a sensitivity of 75 pg/mL when using a 0.01-mL plasma/assay tube.

21. The First International Standard for Human Insulin is indistinguishable from the rat insulin reference standard in this insulin RIA.
22. Immunoassay of insulin released by insulin-secreting xenografts in mice requires an antibody with an affinity for the graft insulin of approx 10^{11} L/mol and virtually no affinity for mouse insulin. We selected a human insulin antibody with a K_a of 5.6×10^{10} L/mol ($K_d = 1.8 \times 10^{-11}$ mol/L or 105 pg/mL) and <0.1% crossreactivity with rat insulin, as the basis for our RIA of human insulin secreted by islet grafts in mice.
23. Delayed addition of the labeled antigen results in a more than 10-fold increase in sensitivity as the ED_{10} , ED_{50} , and ED_{90} of this antiserum shifted from 100, 1050, and 9500 pg/mL (manufacturer's data) to 5, 70, and 1000 pg human insulin/mL, respectively. This converts to a level of detectability of 50 pg/mL when using 0.01 mL of plasma/assay tube.
24. Rat insulin crossreacts 0.4% under the conditions of this assay. Endogenous mouse insulin levels of <12,500 pg/mL would not be detected ($12,500 \text{ pg/mL} \times 0.004 = 50 \text{ pg/mL}$) and would, therefore, not contribute to human insulin measured in the host animal.
25. The recent development of two-antibody-site immunoassays for insulin has provided an alternative method for measurement of this hormone in the mouse. These immunoassays are operated by employing two antibodies raised to separate insulin epitopes. One antibody is tagged for detection and the other is immobilized to facilitate separation of the tagged antibody–insulin-immobilized antibody complex from the tagged antibody not bound to insulin. The amount of tagged antibody–insulin-immobilized antibody complex formed is directly proportional to the amount of insulin present. Manufacturers of these immunoassays have elected to tag the detection antibody by coupling it to either (1) a specific enzyme that is allowed to react with an appropriate substrate, yielding a spectrophotometrically detectable chromogen (the enzyme-linked immunosorbent assay [ELISA]), or (2) an appropriate chemiluminescent substrate that can be induced to emit light (the immunochemiluminiscent assay [ICLA]). At least seven of these immunoassays are commercially available as possible alternatives to the RIAs we have described for measurement of insulin in the mouse (*see Table 1*). Only the four ELISAs designed for measurement of mouse (rat) insulin should be considered as immediate alternatives to the present or other competitive mouse insulin immunoassays (*see Table 1*). The species specificity of these ELISA and ICLA assays is either unknown or so wide that only one combination of any two of them could be used immediately, in place of the present mouse and human RIAs, for assessing insulin secretion in mice bearing human xenografts. This combination of insulin ELISAs (EIA-2048 and EIA-2337) was used to monitor host and human insulin in the plasma of rats following *in vivo* transfection of hind limb soleus muscle with a single intramuscular injection of a wild-type human preproinsulin plasmid and a mutant construct engineered to facilitate furin cleavage (24).

Table 1
Insulin Immunoassays

Species ^a	Format	Range ^b (pg/mL)	Cross-reactivity ^c		Source	Ref.
			Mouse	Human		
Mouse	ELISA	125–3750	100	N/A	Cat. no. 008-10-1150-01 ALPCO Diagnostics, Windham, NH	12,13
Mouse	ELISA	78–5000	100	200	Cat. no. INSKR020 Crystal Chem, Inc., Chicago, IL	
Mouse	ELISA	50–3200	100	545	Cat. no. 90060 Crystal Chem, Inc.	14–22
Human	ELISA	15–1000	N/A	100	Cat. no. 008-10-1132-01 ALPCO Diagnostics	
Human	ICLA	80–24,000	N/A	100	Cat. no. 33410 Beckman Coulter, Inc., Chaska, MN	23
Rat	ELISA	375–13,750	100	120	Cat. no. EIA – 2048 DRG International, Inc., Mountainside, NJ	24
Human	ELISA	15–2000	0.7	100	Cat. no. EIA – 2337 DRG International	24
Rat	RIA	50–2000	100	100	present chapter	9
Human	RIA	50–10,000	0.4	100	present chapter	

^aSpecies for which insulin assay was designed.

^bRange of standard insulin concentrations tested and based on 0.01 mL of standard or sample/well or tube.

^cPercent as related to species for which the insulin assay was designed.

^dN/A: not available.

Acknowledgments

These studies were supported by a Merit Review Award from the VA Research Service, research grants from the National Institutes of Health (DK55233, DK/AI62641), and the Diabetes Research and Training Center at Vanderbilt University (NIH DK20593).

References

1. Lomedico, P., Rosenthal, N., Efstratidadis, A., Gilbert, W., Kolodner, R., and Tizard, R. (1979) The structure and evolution of the two nonallelic rat preproinsulin genes. *Cell* **18**, 545–558.

2. Bell, G. I., Swain, W. F., Pictet, R., Cordell, B., Goodman, H. M., and Rutter, W. J. (1979) Nucleotide sequence of a cDNA clone encoding human proinsulin. *Nature* **282**, 525–527
3. Clark, P. M. (1999) Assays for insulin, proinsulin(s) and C-peptide. *Ann. Clin. Biochem.* **36**, 541–564.
4. Gray, I. P., Siddle, K., Frank, B. H., and Hales, C. N. (1987) Characterization and use in immunoradiometric assay of monoclonal antibodies directed against human proinsulin. *Diabetes* **36**, 684–688.
5. Markussen, J. (1971) Mouse insulins—separation and structures. *Int. J. Protein Res.* **3**, 149–155.
6. Wentworth, B. M., Rhodes, C., Schnetzler, B., Gross, D. J., Halban, P. A., and Villa-Komaroff, L. (1992) The ratio of mouse insulin I:insulin II does not reflect that of the corresponding proinsulin mRNAs. *Mol. Cell. Endocrinol.* **86**, 177–186.
7. Bonnevie-Nielsen, V., Steffes, M. W., and Lernmark, A. (1981) A major loss in islet mass and B-cell function precedes hyperglycemia in mice given multiple low doses of streptozotocin. *Diabetes* **30**, 424–429.
8. Kano, Y., Kanatsuna, T., Nakamura, N., et al. (1986) Defect of the first-phase insulin secretion to glucose stimulation in the perfused pancreas of the nonobese diabetic (NOD) mouse. *Diabetes* **35**, 486–490.
9. Brissova, M., Shiota, M., Nicholson, W. E., et al. (2002) Reduction in pancreatic transcription factor PDX-1 impairs glucose-stimulated insulin secretion. *J. Biol. Chem.* **277**, 11, 225–11,232.
10. Sapin, R., Ongagna, J.-C., Gasser, F., and Grucker, D. (1998) Insulin measurements in haemolysed serum: influence of insulinase inhibitors. *Clin. Chim. Acta* **274**, 111–117.
11. Chevenne, D., Letailleur, A., Trivin, F., and Porquet, D. (1998) Effect of hemolysis on the concentration of insulin in serum determined by RIA and IRMA. *Clin. Chem.* **44**, 354–356.
12. Yang, C., Coker, K. J., Kim, J. K., et al. (2001) Syntaxin 4 heterozygous knockout mice develop muscle insulin resistance. *J. Clin. Invest.* **107**, 1311–1318.
13. Roduit, R., Masiello, P., Wang, S. P., Li, H., Mitchell, G. A., and Prentki, M. (2001) A role for hormone-sensitive lipase in glucose-stimulated insulin secretion: a study in hormone-sensitive lipase-deficient mice. *Diabetes* **50**, 1970–1975.
14. Klamann, L. D., Boss, O., Peroni, O. D., et al. (2000) Increased energy expenditure, decreased adiposity, and tissue-specific insulin sensitivity in protein-tyrosine phosphatase 1B-deficient mice. *Mol. Cell. Biol.* **20**, 5479–5489.
15. Bruning, J. C., Gautam, D., Burks, D. J., et al. (2000) Role of brain insulin receptor in control of body weight and reproduction. *Science* **289**, 2122–2125.
16. Guerra, C., Navarro, P., Valverde, A. M., et al. (2001) Brown adipose tissue-specific insulin receptor knockout shows diabetic phenotype without insulin resistance. *J. Clin. Invest.* **108**, 1205–1213.

17. Mauvais-Jarvis, F., Ueki, K., Fruman, D. A., et al. (2002) Reduced expression of the murine p85{alpha} subunit of phosphoinositide 3-kinase improves insulin signaling and ameliorates diabetes. *J. Clin. Invest.* **109**, 141–149.
18. Withers, D. J., Burks, D. J., Towery, H. H., Altamuro, S. L., Flint, C. L., and White, M. F. (1999) Irs-2 coordinates Igf-1 receptor-mediated beta-cell development and peripheral insulin signalling. *Nat. Genet.* **23**, 32–40.
19. Zisman, A., Peroni, O. D., Abel, E. D., et al. (2000) Targeted disruption of the glucose transporter 4 selectively in muscle causes insulin resistance and glucose intolerance. *Nat. Med.* **6**, 924–928.
20. Abel, E. D., Peroni, O., Kim, J. K., et al. (2001) Adipose-selective targeting of the GLUT4 gene impairs insulin action in muscle and liver. *Nature* **409**, 729–733.
21. Heikkinen, S., Pietila, M., Halmekyto, M., et al. (1999) Hexokinase II-deficient mice. Perinatal death of homozygotes without disturbances in glucose tolerance in heterozygotes. *J. Biol. Chem.* **274**, 22,517–22,523.
22. Baggio, L., Adatia, F., Bock, T., Brubaker, P. L., and Drucker, D. J. (2000) Sustained expression of exendin-4 does not perturb glucose homeostasis, beta-cell mass, or food intake in metallothionein-preproexendin transgenic mice. *J. Biol. Chem.* **275**, 34,471–34,477.
23. Carpenter, M. W., Canick, J. A., Star, J. A., Shellum, C., and Somers, M. (1999) A high-sensitivity assay for amniotic fluid insulin at 14–20 weeks' gestation. *Obstet. Gynecol.* **94**, 778–782.
24. Shaw, J. A., Delday, M. I., Hart, A. W., Docherty, H. M., Maltin, C. A., and Docherty, K. (2002) Secretion of bioactive human insulin following plasmid-mediated gene transfer to non-neuroendocrine cell lines, primary cultures and rat skeletal muscle in vivo. *J. Endocrinol.* **172**, 653–672.

FOR REFERENCE PURPOSES ONLY

Detection of Insulin Production by Immunohistochemistry

Susan C. Campbell and Wendy M. Macfarlane

1. Introduction

Detection of insulin by immunocytochemistry is one of the most powerful and sensitive techniques available to monitor levels of expression in islets (1), β -cells in culture (2), tissue samples (3), and cells transgenically expressing the insulin gene (4). Like all immunocytochemistry techniques, much depends on the availability of a high-quality primary antibody. Species-specific insulin antibodies are now available from a number of commercial sources (including Santa Cruz), and these allow sensitive and specific detection of even very low levels of expression. Described below is the protocol for detection of insulin in β -cell lines in culture, using a FITC-coupled secondary antibody. A broad range of secondary antibodies are also available, including fluorescein isothiocyanate (FITC), tetramethylrhodamine isothiocyanate (TRITC), and biotin-labeling, among others. For cells in culture, two-well, four-well, or eight-well chamber slides are recommended (available from several commercial sources, including Nunc), as these allow rapid and simple processing of large numbers of replicate samples, with small volumes of antibody. However, the following protocol can also be applied to cells grown on coated cover slips. The methods described here are for analysis by fluorescence microscopy. For analysis of insulin expression in intact islets, confocal microscopy would be required (1).

2. Materials

1. Blocking buffer: 0.7% Glycerol, 0.2% Tween-20, 2% bovine serum albumin (BSA). Store at 4°C.

2. Chamber slides.
3. Cover slips.
4. FITC-coupled secondary anti-mouse antibody (Santa Cruz; Molecular Probes).
5. Anti-insulin primary antibody
6. Methanol (ice cold).
7. Phosphate-buffered saline (PBS): 150 mM NaCl, 2.7 mM KCl, 4.3 mM Na₂HPO₄, 1.4 mM KH₂PO₄.
8. Vectashield mounting medium with DAPI (4,6-diamidino-2-phenylindole; Vector Laboratories). Store at 4°C in the dark
9. Wash buffer: 0.7% Glycerol, 0.4% Tween-20, 2% BSA. Store at 4°C.

3. Methods

1. Split insulin-producing cells into eight-well chamber slides and allow to grow until they are approx 50% confluent (*see Note 1*).
2. Wash cells four times in 1X PBS.
3. Fix cells by adding a large volume of ice-cold methanol and incubating at 4°C for 10 min (*see Note 2*).
4. Remove methanol and wash once in 1X PBS.
5. Add 200 µL blocking buffer and incubate at room temperature for 15 min (*see Note 3*).
6. Discard blocking buffer and add insulin primary antibody, which has been diluted 1:400 in 200 µL blocking buffer (*see Notes 4–6*).
7. Incubate at 4°C overnight.
8. Remove primary antibody and wash three times in blocking buffer.
9. Add FITC-coupled secondary antibody, which is diluted 1:400 in 200 µL blocking buffer, and incubate in the dark at room temperature for 1 h, with gentle agitation (*see Notes 7 and 8*).
10. Remove secondary antibody and rinse in wash buffer for 1 h with gentle agitation, in the dark.
11. Mount cells in vectashield with DAPI and affix cover slips (*see Note 9*).
12. Examine by fluorescent microscopy.

4. Notes

1. Cells can be plated onto coated cover slips (glass cover slips coated with 100 mM poly-L-lysine; Sigma) in six-well tissue culture dishes. However, chamber slides (available from Nunc) allow two, four, or eight replicate samples to be processed simultaneously and are easier to handle.
2. As an alternative to methanol, the cells can also be fixed in 4% *p*-formaldehyde in phosphate-buffered saline (PBS) for 20 min at room temperature. Quench in 100 mM glycine in PBS for 15 min at room temperature.
3. For four-well chamber slides, adjust volume to 300 µL, for two-well chamber slides, adjust volume to 500 µL, and for six-well plates, adjust volume to 1 mL.
4. Insulin antibodies are available from a number of commercial sources depending on requirements (Linco Research, Santa Cruz).

5. Because the quality of the primary antibody depends on the source, initial titration of the primary antibody concentration will be required for each new antibody. However, 1:200 to 1:400 is a good starting point for initial experiments.
6. For each primary antibody, replicate control samples are essential, using primary antibody only, secondary antibody only, and preimmune serum (species specific) at the same dilutions as the specific primary/secondary antibodies.
7. FITC-coupled secondary antibodies are available from a number of commercial sources (Santa Cruz, Molecular Probes). Initial titration of antibody concentration will be required for each new antibody; however 1:400 is a good starting point for initial experiments. TRITC- and biotin-labeled secondary antibodies are available from several commercial sources and work equally as well as FITC using this protocol.
8. FITC and TRITC antibodies are light sensitive. Therefore, to decrease background, wrap slides in aluminum foil or incubate in a light proof box.
9. Use 15 μ L vectashield with DAPI per well of an eight-well chamber slide and affix cover slips. DAPI forms fluorescent complexes with double-stranded DNA and is used for staining of the nucleus.

References

1. Shih, D. Q., Heimesaat, M., Kuwajima, S., Stein, R., Wright, C. V. E., and Stoffel, M. (2002) Profound defects in pancreatic β -cell function in mice with combined heterozygous mutation in PDX-1, HNF-1 α , and HNF-3 β . *Proc. Natl. Acad. Sci. USA* **99**, 3818–3823.
2. Macfarlane, W. M., Campbell, S. C., Elrick, L. J., et al. (2000) Glucose regulates islet amyloid polypeptide gene transcription in a PDX1- and calcium-dependent manner. *J. Biol. Chem.* **275**, 15,330–15,335.
3. Jonsson, J., Carlsson, L., Edlund, T., and Edlund, H. (1994) Insulin-promoter-factor 1 is required for pancreas development in mice. *Nature* **13**, 606–609.
4. Shaw, J. A., Delday, M. I., Hart, A. W., Docherty, H. M., Maltin, C. A., and Docherty, K. (2002) Secretion of bioactive human insulin following plasmid-mediated gene transfer to non-neuroendocrine cell lines, primary cultures and rat skeletal muscle in vivo. *J. Endocrinol.* **172**, 653–672.

FOR REFERENCE PURPOSES ONLY

Quantification of the Level of Insulin Gene Expression

Susan C. Campbell and Wendy M. Macfarlane

1. Introduction

Insulin gene expression levels can be detected and quantified using a broad range of molecular biology techniques. Traditionally, detection of insulin mRNA levels in both β -cell lines and purified islets has been performed by Northern blot analysis, using the full-length insulin cDNA as a labeled probe (*1*). This technique is described here, and is still the most useful method for detection of endogenous insulin mRNA levels (densitometry being applied to allow quantification of band intensities). A more rapid analysis of endogenous mRNA levels can be performed by reverse transcriptase–polymerase chain reaction (RT-PCR), which is also described here. RT-PCR allows analysis of insulin mRNA levels from even small amounts of cells or tissue and can be used to analyze expression in as little as a single islet. Like Northern blotting, prior purification of high-quality RNA is essential for this technique and there are several commercial RNA preparation kits available (e.g., RNeasy from Qiagen). Such commercially available kits can also be used to isolate poly-A⁺ RNA (mRNA) only, which assists in decreasing background signals. To investigate both rapid and long-term effects on insulin gene expression, advances in reporter gene technology have allowed the development of synthetic constructs containing the insulin gene promoter. When transiently transfected into β -cells and β -cell lines, these can now be used to estimate changes in insulin gene expression through measurement of insulin gene promoter activation. Insulin-promoter reporter gene constructs allow rapid and easily quantifiable analysis of expression in a range of cell lines, and in response to external cues, they have become increasingly popular in the analysis of insulin gene expression.

Described here is a protocol for analysis of firefly luciferase reporter gene activity, as this is the most common reporter used in analysis of the human insulin gene promoter (2). However, several alternative reporter genes are also available for insulin promoter studies, including the bacterial enzymes β -galactosidase (3) and CAT (chloramphenicol acetyl transferase), which was the reporter gene first used to analyse insulin gene promoter activation (4). Luciferase assays are described here, as these are the easiest, quickest, and most sensitive assays currently in use for the analysis of insulin gene promoter activation.

2. Materials

2.1. Transfection

1. Cell culture medium containing 2X serum concentration: Dulbecco's modified Eagle's medium (DMEM) plus 20% fetal bovine serum (FBS) (Sigma or Hyclone).
2. Lipofectamine reagent (Invitrogen) or other commercially available products.
3. Optimem I Reduced Serum Medium (Invitrogen).
4. Phosphate-buffered saline (PBS): 150 mM NaCl, 2.7 mM KCl, 4.3 mM Na₂HPO₄, 1.4 mM KH₂PO₄.
5. Plasmid DNA-reporter gene construct containing the full length, or a part, of the insulin gene promoter.

2.2. Preparation of Cell Extracts from β -Cell Lines

1. Phosphate buffer: 0.1 M KH₂PO₄ (pH 7.8), 1 mM dithiothreitol (DTT). Filter-sterilize and store at -20°C .

2.3. Luciferase Assay

1. Buffer A: 15 mM MgSO₄, 30 mM glycylglycine (pH 7.8), 2 mM Na₂ATP. Store at -20°C .
2. Buffer G: 30 mM glycylglycine (pH 7.8). Store at -20°C .
3. 10 mM Luciferin, light sensitive. Make up this solution in 30 mM glycylglycine (pH 7.8) and store at -20°C . Add 250 μL 10 mM luciferin to 5 mL buffer G to obtain final luciferin concentration of 0.5 mM.

2.4. Northern Blotting

2.4.1. Electrophoresis

1. 1.5% Agarose/formaldehyde gel: 5.25 g agarose, 262.5 mL distilled water, 52.5 mL formaldehyde, 35 mL 10X 3-*N*-(morpholino) propanesulfonic acid (MOPS) (pH 7.0). Formaldehyde is toxic and should be added, and gels should be poured in a fume hood.
2. Diethyl pyrocarbonate (DEPC)-treated water.
3. Loading buffer (250 μL of 100% deionized formamide, 83 μL formaldehyde, 50 μL 10X MOPS pH 7.0, 50 μL of 100% glycerol, 10 μL of 2.5% bromophenol blue, 57 μL DEPC-treated water). Deionized formamide is toxic and should be treated with care. Prepare fresh.

4. 10X MOPS, pH 7.0: 200 mM MOPS, 50 mM NaAc, 20 mM EDTA. This should be double-autoclaved to sterilize.
5. Running buffer (1X MOPS, pH 7.0).

2.4.2. RNA Transfer and Fixation

1. Hybond N⁺ membrane (Whatman).
2. 20X SSC: 3 M NaCl, 0.30 M sodium citrate. Autoclave to sterilize.
3. Whatmann 3MM paper.

2.4.3. Hybridization

1. 50X Denhardt's solution: 1 g Ficoll, 1 g polyvinyl pyrrolidone, 1 g bovine serum albumin (BSA), fraction V. Filter-sterilize and store in aliquots at -20°C .
2. Insulin cDNA probe.
3. [α - ^{32}P]dCTP or a nonradioactive labeling system.
4. Prehybridization buffer: 5X SSC, 5X Denhardt's solution, 0.5% sodium dodecyl sulfide (SDS). Prepare fresh.
5. 10% SDS.
6. Sonicated salmon sperm DNA.

2.5. Reverse Transcriptase–Polymerase Chain Reaction

All reagents for both the reverse transcription and PCR used in this protocol are widely available from a number of commercial sources (e.g., Promega).

1. DEPC-treated water.
2. Insulin gene primers:
5' Primer (20 pmol/ μL): 5' GCGGGCTGCGTCTAGTTGCAGTAG-3';
3' primer (20 pmol/ μL): 5' ATGGCCCTGTGGATGCGCCTCCTG-3'.
3. 25 mM MgCl₂.
4. Mineral oil.
5. Oligo(dT).
6. 10X PCR buffer.
7. Reverse transcriptase (Moloney murine leukemia virus, MMLV-RT).
8. RNase inhibitor.
9. RNase-free distilled water.
10. Stock solutions of NTPs and dNTPs.
11. 5X First-strand buffer (for reverse transcription).
12. *Taq* DNA polymerase.

3. Methods

3.1. Transfection

1. Twenty-four hours before transfection, cells are split into six-well tissue culture plates and should be approx 50–80% confluent for the transfection procedure.

2. Prepare the following in sterile tubes: For each well of a six-well plate, dilute 2 μg of DNA and 5 μL of lipofectamine reagent into 1 mL serum-free medium (e.g., Optimem I Reduced Serum Medium), and vortex to mix (*see Notes 1 and 2*).
3. Incubate the solution at room temperature for 30 min to allow DNA–liposome complexes to form.
4. While the solution is incubating, wash the cells 1X in PBS, add 1 mL of Optimem I to the cells, and incubate at 37°C.
5. After the DNA–liposome complexes have been incubated for 30 min, remove the Optimem I medium from the cells and add 1 mL of the DNA–liposome solution to the cells.
6. Incubate the cells for 5 h at 37°C (*see Note 3*).
7. Following incubation, add 1 mL of complete growth medium containing twice the normal concentration of serum without removing the transfection mixture.
8. Replace the medium with fresh complete medium 18–24 h following the start of the transfection.
9. If cells are to be stimulated, they should be stimulated 48 h posttransfection, prior to harvesting cells (*see Note 4*).

3.2. Preparation of Cell Extracts from β -Cell Lines

1. Harvest cells 48 h posttransfection. To do this, remove media from the cells and wash once in 2 mL PBS.
2. Add 1 mL PBS to each well and dislodge the cells from the plate by scraping the cells with a cell scraper.
3. Pellet the cells by transferring to a microcentrifuge tube and centrifuging at 10,000g for 3 min.
4. Resuspend the cell pellet in 40–100 μL of 0.1 M KH_2PO_4 (pH 7.8) containing 1 mM DTT and store samples on ice.
5. Lyse cells by freeze–thawing three times. This involves freezing samples rapidly in liquid nitrogen and then thawing in a 37°C water bath. Vortex samples between each cycle.
6. Remove cell debris by centrifuging at 10,000g for 30 s (*see Note 5*).

3.3. Luciferase Assay

1. For a standard luminometer (e.g., Berthold, Sirius luminometer), select one injector with an injection volume of 150 μL and a measuring time of 10 s. Luciferase values should be in relative light units (RLUs).
2. Prepare buffer G containing luciferin. This is used as the luciferase assay substrate.
3. Before beginning the assay, wash (or prime) the luminometer by carrying out the wash cycle three times with distilled water, followed by three times with the luciferase assay substrate.
4. Aliquot 350 μL buffer A into 5-mL tubes (Sarstedt) for each of the samples to be assayed, including one for a background count.

5. Begin the assay by obtaining a background count. Place the control tube into the luminometer, and to this 150 μL buffer G containing 0.5 mM luciferin is injected (see **Notes 6** and **7**).
6. For each of the samples to be assayed, add approx 20 μL of cell extract to 350 μL buffer A, place the tube in the luminometer, and measure the luminescence.
7. After completing the assay, the luminometer should be washed through by carrying out the wash cycle three times with distilled water or until there is no trace of luciferin in the injection tube.

3.4. Northern Blotting

3.4.1. Electrophoresis

1. Prepare 1.5% agarose/formaldehyde gel. To do this, add the agarose to distilled water and heat in a microwave until the agarose has melted. Allow the solution to cool to about 60°C and then add the MOPS and formaldehyde (see **Note 8**).
2. To prepare samples, add 2–3 volumes of Northern loading buffer to 1 μg RNA (i.e., 20 μL loading buffer and 10 μL RNA) (see **Note 9**).
3. Denature samples at 65°C for 10 min.
4. Chill samples rapidly on ice for 1 min.
5. Run gel at 100 V for about 3.5 h.

3.4.2. RNA Transfer and Fixation

1. Prior to blotting, wash the gel two times for 15 min in 20X SSC at room temperature with gentle agitation, to remove the formaldehyde.
2. Transfer the RNA by capillary transfer. Set up the following transfer apparatus (see **Fig. 1**):
 - a. The blot apparatus needs to be placed within a dish that contains a raised support for the gel. Cut one piece of Whatmann 3MM filter paper to the same width as the raised support, and slightly longer so it will act as a wick. Prewet the filter paper in 20X SSC and place over the raised support.
 - b. Place the gel on top of the filter paper and seal the edges with Saran Wrap™.
 - c. Place a piece of Hybond N⁺ membrane cut to the same size of the gel on top of the gel. Handle the membrane using gloves and forceps. Remove any air bubbles by rolling them out.
 - d. Cover the membrane with three pieces of Whatmann 3MM paper cut to size and soaked in 20X SSC, followed by an additional three pieces of dry Whatmann 3MM paper.
 - e. Place a 3- to 5-cm stack of dry paper towels on top of the filter paper, weighted down with an approx 500-g weight.
 - f. Fill the dish with 20X SSC and leave to transfer overnight.
3. After blotting is complete, rinse the membrane two times briefly in 2X SSC and fix the RNA onto the membrane by baking at 80°C for 2 h (see **Notes 10** and **11**).

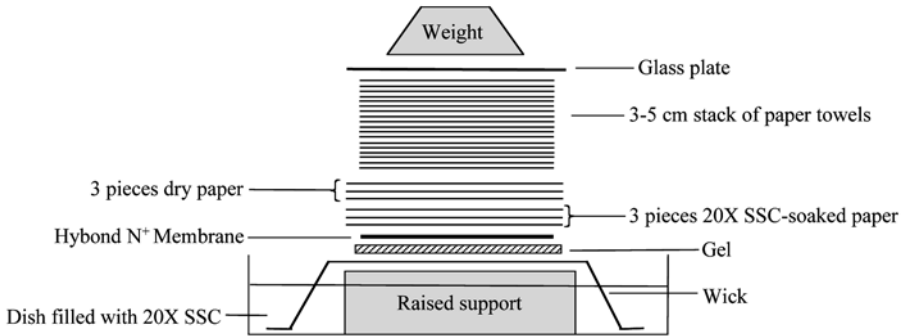

Fig. 1. Schematic representation of Northern blot transfer apparatus.

3.4.3. Hybridization

1. Prepare the prehybridization solution.
2. Denature 0.5 mg of sonicated salmon sperm DNA by heating to 100°C for 5 min and rapidly chilling on ice. Add to the prehybridization solution.
3. Place membrane in a hybridization bottle, add the prehybridization solution and incubate with rotation at 68°C for 1 h in a hybridization oven.
4. Denature the labeled probe by heating at 95°C for 5 min (*see Note 12*).
5. Add the probe to the prehybridization solution and incubate with rotation at 68°C overnight (*see Note 13*).
6. Following hybridization wash the membrane twice in 2X SSC/0.1% SDS at room temperature for 10 min followed by a final wash in 1X SSC/0.1% SDS at 68°C for 15 min (*see Note 14*).
7. Remove the filter, wrap in Saran Wrap, expose to X-ray film, and visualize by autoradiography (*see Note 15*).

3.4.4. Stripping the Membrane

1. To strip the membrane so that it can be reprobed, boil a solution containing 0.1X SSC and 0.1% SDS. Pour this solution over the filter and incubate with agitation for 10 min.
2. **Step 1** should be repeated until the radioactivity cannot be detected (*see Note 16*).

3.5. Reverse Transcriptase–Polymerase Chain Reaction

1. In a microcentrifuge tube, adjust the volume of 1 µg total RNA up to 12.9 µL with DEPC-treated water.
2. To the reaction tube, add 1 µL (0.5 µg) of driving primer [oligo(dT)] and mix gently.
3. Incubate at 70°C for 10 min, and then chill on ice for 1 min.
4. To the reaction mix, add the following, in order:

4 μL	5X first-strand buffer
1 μL	RNase inhibitor (40 U/ μL)
1 μL	NTP mix (25 mM)
0.1 μL	MMLV-RT (200 U/ μL)

Mix gently.

- Incubate the reaction mix at room temperature for 10 min, followed by 1 h at 37°C.
- Heat inactivate the enzyme at 90°C for 5 min and then chill on ice for 10 min (*see Note 17*).
- Set up the PCR reaction as follows:

1 μL	reverse transcription mix	
2.5 μL	insulin 5' and 3' primers (20 pmol/ μL)	
5 μL	dNTP mix (2 mM)	
3 μL	MgCl ₂ (25 mM)	
5 μL	10X PCR buffer	
0.5 μL	Taq DNA polymerase	(5U/ μL)

 to a final volume of 50 μL with RNase-free distilled water.
- Overlay the reaction mix with mineral oil. Run the PCR reaction for an initial denaturation step at 95°C for 10 min, followed by 35 cycles (denaturation for 15 s at 95°C, hybridize primers at 60°C for 40 s, primer extension at 72°C for 2 min).
- Transfer the lower layer to a fresh microcentrifuge tube (*see Note 18*).
- Products can be visualized by agarose gel electrophoresis.
- This protocol is not appropriate for quantitative RT-PCR (*see Note 19*).

4. Notes

- The lipofectamine reagent should be vortexed before adding to the solution.
- The DNA and lipofectamine ratios can vary for a variety of cell types and the amount of lipofectamine and DNA required to give optimal transfection efficiency can be titrated. The values suggested here are for standard transfection of β -cell lines such as MIN6 (5) and β -TC (6).
- This should be optimized for the cells in question; however, 5 h is a good starting point.
- This method describes measuring luciferase activity by performing a standard luciferase assay; however, luciferase expression can also be measured by single-cell imaging techniques (7).
- Samples can be frozen at -20°C and assayed at a later stage.
- Before placing the tube in the luminometer, wipe the tube with ethanol to reduce interference. Also, store tubes out of direct sunlight, as this can interfere with measurements.
- The value obtained should be in the region of 100, and if it is much higher, the luminometer should be washed through again with distilled water.
- The formaldehyde should be added and the gel should be poured in a fume hood.

9. RNA can be prepared by several standard protocols. Qiagen's RNeasy kits, or equivalent, are recommended. For low-copy-number transcripts, polyA⁺ selection kits are also commercially available (Qiagen).
10. The RNA can also be fixed onto the membrane by ultraviolet (UV)-crosslinking for 3–5 min.
11. The membrane can be stored dry at 4°C, wrapped in Saran Wrap.
12. The ideal probe is the full-length insulin cDNA labeled with [α -³²P]dCTP. There are a number of commercially available labeling systems to radioactively label the probe (i.e., Ready-to-go labeling beads available from Pharmacia). There are also a number of other nonradioactive labeling systems, which are now widely available and becoming increasingly popular because of safety implications (e.g., [Roche]).
13. The prehybridization and hybridization temperatures may have to be adjusted and optimized depending on the homology of the probe to the target. (High temperature increases stringency of hybridization, and low temperature decreases stringency.) The values suggested here are for a full-length species-specific insulin probe.
14. The stringency of the washes will have to be determined for the probe, and it might be necessary to adjust the salt concentration. Low salt concentration increases stringency of hybridization, and high salt concentration decreases stringency.
15. This should be stored at –70°C for the appropriate exposure time if using a [α -³²P]dCTP-labeled probe.
16. Membranes can only be stripped and reprobbed if they did not dry out during and after hybridization and washing.
17. The reaction mix can be stored at –70°C.
18. Reaction mix can be stored at –20°C.
19. For quantitative RT-PCR, see ref. 8.

References

1. Giddings, S. J., Rotwein, P., Chirgwin, J. M., Scharp, D., and Permutt, M. A. (1983) Analysis of insulin gene expression in human pancreas. *Diabetes* **32**, 777–780.
2. Macfarlane, W. M., McKinnon, C. M., Felton-Edkins, Z. A., Cragg, H., James, R. F., and Docherty, K. (1999) Glucose stimulates translocation of the homeodomain transcription factor PDX1 from the cytoplasm to the nucleus in pancreatic beta-cells. *J. Biol. Chem.* **274**, 1011–1016.
3. Wu, K. L., Gannon, M., Peshavaria, M., et al. (1997) Hepatocyte nuclear factor 3 beta is involved in pancreatic beta-cell-specific transcription of the pdx-1 gene. *Mol. Cell. Biol.* **17**, 6002–6013.
4. Walker, M. D., Edlund, T., Boulet, A. M., and Rutter, W. J. (1983) Cell-specific expression controlled by the 5'-flanking region of insulin and chymotrypsin genes. *Nature* **306**, 557–561.
5. Miyazaki, J., Araki, K., Yamato, E., et al. (1990) Establishment of a pancreatic beta cell line that retains glucose-inducible insulin secretion: special reference to expression of glucose transporter isoforms. *Endocrinology* **127**, 126–132.

6. Efrat, S., Linde, S., Kofod, H., et al. (1988) Beta-cell lines derived from transgenic mice expressing a hybrid insulin gene-oncogene. *Proc. Natl. Acad. Sci. USA* **85**, 9037–9041.
7. Rutter, G. A., Kennedy, H. J., Wood, C. D., White, M. R., and Tavare, J. M. (1998) Real-time imaging of gene expression in single living cells. *Chem. Biol.* **5**, R285–R290.
8. Bustin, S. A. (2000) Absolute quantification of mRNA using real-time reverse transcription polymerase chain reaction assays. *J. Mol. Endocrinol.* **25**, 169–193.

FOR REFERENCE PURPOSES ONLY

Chromatin Immunoprecipitation Using Isolated Islets of Langerhans

Marcelina Párrizas, Sylvia F. Boj, Reini F. Luco,
Miguel Angel Maestro, and Jorge Ferrer

1. Introduction

The study of transcriptional processes in higher eukaryotes has been limited by the scarce availability of *in vivo* assays. This shortage of technical approaches has become more important in light of the emerging notion that the natural chromatin context affects the outcome of transcriptional activation *in vivo* (1). Chromatin can exert a regulatory effect on transcription by modulating the access of activators to DNA (1). Different posttranslational modifications of specific residues in the N-terminal tails of the nucleosomal histones have been characterized as a signal code that is linked to the active or inactive transcriptional status of promoters (2). These modifications, including acetylation, methylation, phosphorylation, and ubiquitination, are thought to result from the targeted binding to promoters of transcriptional coactivator or corepressor complexes containing such enzymatic activities. These complexes do not generally possess DNA-binding activity, but are recruited to promoters by their interaction with sequence-specific transcription factors (3). The resulting modifications of the histone tails, in turn, modulate the access of further regulatory complexes to the promoter (4). This subtle regulatory interplay can easily be missed when transcriptional activation or transcription factor binding to target promoters is studied *in vitro* using naked DNA templates.

In this respect, chromatin immunoprecipitation (ChIP) assays are being quickly established as a powerful method to examine the access of nuclear proteins to their target promoters in the natural chromatin environment, as well as

to analyze the posttranslational modifications of the histones that conform the nucleosomes spanning promoters of interest (5–10). This procedure was initially developed for use in *Drosophila* and yeast, starting with relatively large quantities of cells, by which reason its usefulness in animal tissues from which only limited amounts of cells are available was compromised (5–7). We and others have recently developed small-scale ChIP assays for the study of histone acetylation and transcription factor binding in animal tissues such as mouse pancreatic islets or hepatocytes (11–13).

An outline of the method is provided in **Fig. 1**. The ChIP procedure rests on the ability of formaldehyde to reversibly crosslink amino and imino groups of both amino acids and DNA that are found within a maximal distance of 2 Å from each other (7). This short range of action ensures that the protein–protein or protein–DNA crosslinks generated by these means represent intimate interactions. Furthermore, as its action is immediate, formaldehyde crosslinking provides a snapshot of interactions in the cell at a determined time-point (14). Using specific antibodies to precipitate the protein of interest, either transcription factor or histone, we can pull with it the DNA sequences to which this protein is bound. To this end, DNA should be previously fragmented into small pieces by some methodology (usually sonication) producing random breaks, so that the selected DNA really represents the sequences found in the immediate vicinity of the immunoprecipitated protein. As formaldehyde-generated crosslinks are easily reversible, immunoselected DNA can be separated from the proteins and purified. The immunoprecipitated DNA should be significantly enriched in those sequences associated with the protein of interest. The enrichment of specific DNA sequences in the immunoprecipitate can be easily analyzed by semiquantitative polymerase chain reaction (PCR) using primers recognizing a region of interest.

Some critical points of the ChIP assay are the optimization of the extent of fixation, the sonication of the chromatin sample to obtain adequately sized DNA fragments, and the availability of an antibody that will recognize and immunoprecipitate its epitope when proteins are fixed and partially denatured in formaldehyde. The fixation step needs to be optimized for each new antibody tested by performing a time-course experiment. Overfixation results in the samples becoming refractory to sonication and, consequently, loss of material during centrifugation steps. Excessive fixation could also result in masking of the epitopes and inefficient immunoprecipitation. The optimal size of the sonicated DNA for use in ChIP experiments ranges from 0.4 to 2 kb. Obtaining adequately sized DNA fragments by sonication is critical for the success of the experiment and the interpretation of the results. A ChIP experiment performed with excessively long DNA fragments will result in the selection of DNA sequences that may not be in the immediate vicinity of the protein precipitated. This issue

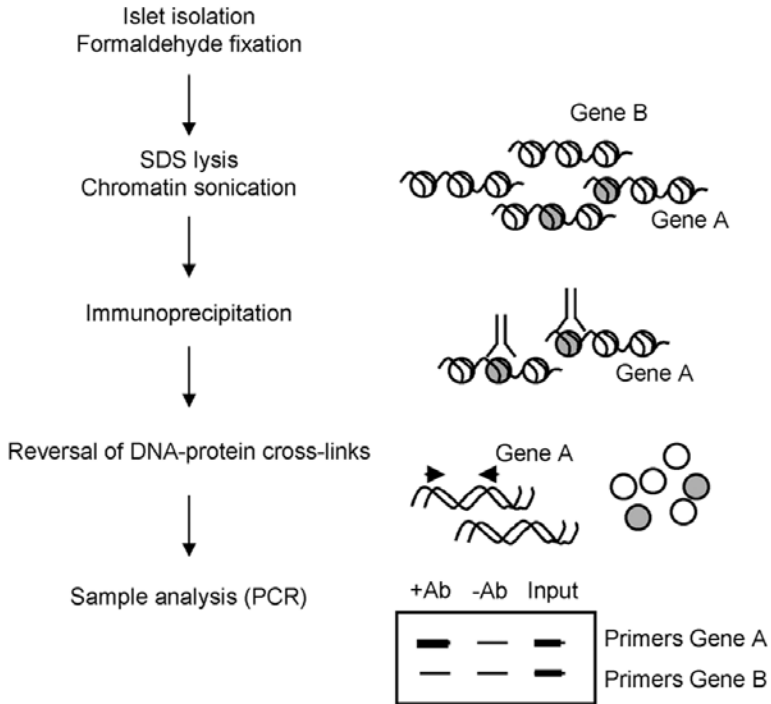

Fig. 1. Schematic outline of the ChIP procedure. Islets are fixed right after isolation by incubating in 1% formaldehyde and then lysated in sodium dodecyl sulfate (SDS) buffer. Chromatin is sonicated to obtain small-sized fragments. Sonicated chromatin is immunoprecipitated with an antibody raised against a DNA-binding protein of interest, so that the DNA sequences to which this protein is bound are selected. The presence of a particular sequence in the selected DNA is detected by polymerase chain reaction (PCR).

becomes crucial if high-resolution fine mapping is intended. The availability of a suitable antibody can also represent a crucial factor. When testing a new antibody, pilot immunoprecipitation experiments using unfixed nuclear extracts followed by Western blot analysis can indicate if the antibody is active in the conditions used for immunoprecipitation in the ChIP assay. On the other hand, immunocytochemical experiments can provide indications regarding the ability of an antibody to recognize its epitope in fixed material. Finally, one of the most critical factors for the success of a ChIP experiment is the availability of a robust readout assay to unequivocally determine the existence of enrichment of specific DNA segments in the immunoprecipitate.

The purpose of this chapter is to provide specific guidelines to carry out ChIP experiments with isolated pancreatic islets of Langerhans. The proce-

ture is based on several established ChIP protocols (6,7,9,13), but specific variables have been systematically tested to optimize the assay for this particular tissue.

2. Materials

1. Formaldehyde (35%) stabilized with 10% methanol (Merck, Whitehouse Station, NJ).
2. Formaldehyde dilution buffer: 50 mM HEPES (pH 8.0), 100 mM NaCl, 1 mM EDTA, 0.5 mM EGTA.
3. Glycine 1.25 M in distilled water (can be stored for several days at 4°C).
4. Sodium dodecyl sulfate (SDS) lysis buffer: 15 mM Tris-HCl (pH 8.0), 10 mM EDTA, 1% SDS. Can be stored at 4°C for long periods of time, but it should be equilibrated at room temperature before using it.
5. ChIP dilution buffer: 16.7 mM Tris-HCl (pH 8.0), 0.01% SDS, 1.1% Triton X-100, 1.2 mM EDTA, 167 mM NaCl. Add 1 mM phenylmethylsulfonyl fluoride (PMSF) and protease inhibitor cocktail before use. A low-salt version can also be prepared with 90 mM NaCl.
6. Salmon sperm DNA/protein A-agarose (50% slurry): 0.5 g protein-A CL-4B (Amersham Pharmacia Biotech, Uppsala, Sweden) inflated with 2 mL dH₂O for 15 min at room temperature on a rotating wheel. Pellet beads by centrifugation at 1000g for 1 min and discard supernatant. Repeat washing two more times with dH₂O and once with TE. Resuspend the final pellet in 1 mL TE and supplement with 200 µg sonicated salmon sperm DNA and 500 µg bovine serum albumin (BSA).
7. Anti-diacetylated histone H3 (Upstate Biotechnology Inc. [UBI], Waltham, MA, cat. no. 06-599) or anti-tetra-acetylated histone H4 (UBI, cat. no. 06-598).
8. Low-salt immune complex wash buffer: 20 mM Tris-HCl (pH 8.0), 0.1% SDS, 1% Triton X-100, 2 mM EDTA, 150 mM NaCl.
9. High-salt immune complex wash buffer: 20 mM Tris-HCl (pH 8.0), 0.1% SDS, 1% Triton X-100, 2 mM EDTA, 500 mM NaCl.
10. LiCl immune complex wash buffer: 10 mM Tris-HCl (pH 8.0), 0.25 M LiCl, 1% NP40, 1% Na deoxycholate, 1 mM EDTA.
11. TE buffer: 10 mM Tris-HCl (pH 8.0), 1 mM EDTA.
12. Elution buffer: 1% SDS, 0.1 M NaHCO₃. Prepare fresh before use.
13. 5 M NaCl.
14. 1 M Tris-HCl, pH 6.5.
15. 0.5 M EDTA, pH 8.0
16. 10 mg/mL Proteinase K diluted in dH₂O. Store in small aliquots at -20°C.
17. Glycogen (20 mg/mL) (Roche, Mannheim, Germany).
18. PCR primers and reagents.
19. Equipment: A sonifier equipped with a microprobe is needed. We use a Sonoplus sonifier (Bandelin Electronic, Berlin, Germany) with a MS-72 microprobe. A rotating wheel is used for the overnight immunoprecipitations. DNA size is analyzed by agarose gel electrophoresis. PCR results are analyzed by acrylamide electrophoresis.
20. Glass beads (Sigma, St. Louis, MO; cat. no. G8872)

3. Methods

3.1. Formaldehyde Crosslinking and DNA Fragmentation

1. Prepare crosslinking solution by diluting 35% formaldehyde in formaldehyde dilution buffer to reach a final concentration of 1%. Add crosslinking solution to the freshly isolated islets maintained in either culture medium (generally RPMI supplemented with 10% fetal calf serum) or Hank's balanced salt solution (HBSS) to reach a final concentration of 1% formaldehyde (*see Note 1*). Incubate 10 min at room temperature (*see Note 2*).
2. Stop fixation by adding 1.25 M glycine to attain a final concentration of 125 mM. Glycine quenches the fixation reaction by providing excess amino groups.
3. Centrifuge islets at 2000g and discard supernatants. Resuspend pellets in 1 mL phosphate-buffered saline (PBS) buffer and transfer to an Eppendorf tube. Wash the cells twice in PBS, centrifuging each time, to remove formaldehyde remains. At this point, the addition of protease inhibitors to the buffers or processing at low temperature is not necessary as proteins are fixed.
4. Centrifuge samples in microfuge at maximal speed for 2 min. Resuspend pellets in 0.2–0.4 mL SDS lysis buffer at room temperature (*see Note 3*). Incubate 10 min at room temperature with gentle agitation (e.g., in a rotating wheel). Incubation with SDS will break the cellular and nuclear membranes and expose the fixed chromatin, thus facilitating sonication.
5. Sonicate samples to generate ideally fragments with an average size of 0.4–2 kb (*see Note 4*). For a volume of 150–400 μL in an Eppendorf tube, we insert the sonifier tip to a distance of about 5–10 mm from the bottom of the tube, without touching the walls (*see Note 4*). Sonicate at maximum power for six 30-s intervals at continuous setting, maintaining samples on ice to minimize foaming. Foaming occurs when air is aspirated into the sample by turbulences. As the sample is in a high concentration of SDS, foaming will inevitably occur. Wait several minutes between pulses to allow for foaming to subside. Fragment size should be checked by gel electrophoresis in a parallel experiment or in an aliquot of the sample by reverting the crosslinking and extracting DNA, as described below. When optimizing conditions for a new antibody, it is usually a good idea to store samples at 4°C while crosslinking is reverted in an aliquot and the DNA size is checked, so that the immunoprecipitation experiment may be continued only if sonication is adequate. Fixed chromatin samples can be stored at 4°C for at least 1 wk if protease inhibitors are added. **Figure 2** shows adequately sized DNA fragments obtained from 100 islets in a 150- μL volume.
6. After sonication, centrifuge samples in microfuge at maximum speed (20,000g) for 1 h at 4°C to remove cellular debris and high-molecular-weight DNA–protein aggregates.

3.2. Immunoprecipitation

1. Recover supernatants after centrifugation and transfer to a new tube. Dilute samples 10-fold using ChIP dilution buffer (*see Note 5*). Samples will then be in conditions suitable for immunoprecipitation.

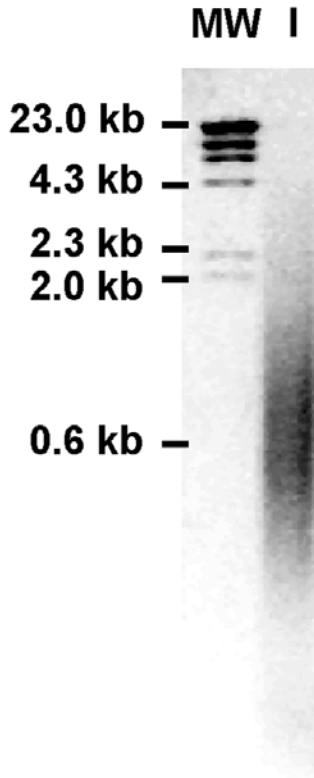

Fig. 2. Example of sonicated islet DNA of a suitable size for immunoprecipitation. Approximately 100 islets were sonicated in 150 μL of SDS lysis buffer for six 30-s pulses with the sonifier microtip at maximum output. Crosslinks were reverted and DNA was recovered as described in the text and analyzed by electrophoresis in a 1% agarose gel stained with ethidium bromide. Fragment size ranges from 0.4 to 2 kb.

2. Preclear samples prior to immunoprecipitation by incubating every 0.5 mL with 30 μL salmon sperm DNA/protein A for 1 h at 4°C with gentle rotation.
3. Centrifuge samples and recover supernatant in new Eppendorf tubes. Generally use 0.5 mL for each individual immunoprecipitation.
4. Add antibody: 1–2 μg for antiacetylated histone H3 or H4 (UBI) and for other monoclonal or polyclonal affinity purified antibodies, an empirical amount for other serums. Add preimmune IgGs or unrelated serum to one sample, which will be the negative control to check for specificity of the assay (*see Note 6*).
5. Incubate overnight at 4°C on a rotating wheel.
6. Centrifuge samples at maximum speed in microfuge for 2 min and transfer supernatants to new tubes. This step is necessary to precipitate and discard any aggre-

gates that may have formed during the overnight incubation and that would otherwise be nonspecifically precipitated in the following steps.

7. Add 30 μL salmon sperm DNA/protein A to each 500 μL sample and continue incubation for 1–3 h at 4°C, to allow for the antibody–protein A complexes to form.
8. Centrifuge samples 2 min in a microfuge at maximum speed and discard supernatants. The supernatant of the control immunoprecipitation (performed with non-immune or unrelated serum) can be kept to be used as input DNA control (*see Note 7*) for the PCR analysis of the experiment.
9. Wash pellets with 1 mL low-salt immune complex wash buffer for 3–5 min at room temperature on rotating wheel. Centrifuge 2 min in a microfuge at maximum speed and discard supernatants.
10. Wash pellets with 1 mL high-salt immune complex wash buffer for 3–5 min at room temperature on rotating wheel. Centrifuge 2 min in microfuge at maximum speed and discard supernatants. These washing steps are intended to eliminate nonspecific protein–antibody interactions.
11. Wash pellets with 1 mL LiCl immune complex wash buffer for 3–5 min at room temperature on a rotating wheel. Centrifuge 2 min in microfuge at maximum speed and discard supernatants. This washing step eliminates low-affinity protein–antibody interactions.
12. Wash pellets three times with 1 mL TE buffer for 3–5 min at room temperature on a rotating wheel to eliminate excess LiCl in the samples. Centrifuge 2 min in microfuge at maximum speed and discard supernatants.
13. Elute samples by adding 200 μL elution buffer prepared fresh and incubating for 15 min at room temperature on a rotating wheel.
14. Centrifuge 2 min in microfuge at maximum speed. Recover supernatants and transfer to new tubes. Add 200 μL elution buffer to the beads and repeat elution for another 15 min.
15. Centrifuge 2 min in a microfuge at maximum speed. Recover supernatant and pool with the first elution (total 400 μL per sample). The eluate contains the selected proteins with the associated DNA.

3.3. Reversal of Crosslinks and Analysis of the Samples

1. Add 16 μL of 5 M NaCl to samples and input DNA (200 mM NaCl final concentration) and revert crosslinks by incubating at 65°C at least 4 h to overnight. Formaldehyde crosslinks are easily reverted by incubation at high temperatures in the presence of salts and detergents.
2. Add 8 μL of 0.5 M EDTA, 16 μL of 1 M Tris-HCl (pH 6.5), and 1.6 μL 10 mg/mL Proteinase K and incubate samples for 1–2 h at 45°C or overnight at 37°C to digest proteins.
3. Recover DNA by phenol : chloroform extraction and ethanol precipitation. Add 1 volume phenol : chloroform (1 : 1) to samples and vortex. Centrifuge for 5 min in a microfuge at maximum speed and recover the aqueous phase in a new Eppendorf tube. Then add 1 volume chloroform and repeat extraction. Precipitate DNA from the final aqueous phase by adding 1/10 volume 3 M sodium acetate (pH 5.3), 20 μg glycogen as carrier, and 2 volumes 100% ice-cold ethanol. Incubate 1 h to overnight at –20°C. Centrifuge samples in microfuge at maximum speed for 10 min at 4°C. Discard supernatant

and wash pellets with 1 mL 70% ethanol at room temperature. Repeat centrifugation and discard supernatants. Allow the pellets to air-dry for several minutes.

4. Resuspend DNA in TE (*see Note 8*), using the same volume for all samples.
5. Analyze the samples by PCR (*see Note 9*). We recommend using multiplex PCR primer pairs including, preferably, a promoter that is not modified by the experimental conditions (as a positive control, intended to correct for different recovery efficiencies) and one that is not expected to be immunoprecipitated (as a negative control or internal control for specificity). Test a series of dilutions of the input DNA that gives signal intensities within the same range as experimental samples and compare different dilutions to ensure that all products within the multiplex reaction are being amplified at similar efficiencies. Amplify for the minimum number of cycles required to visualize a signal. The use of ethidium bromide-stained acrylamide gels increases sensitivity relative to agarose, thus allowing for reduced cycle number. Use low-exposed images for semiquantitation of signal intensity with an image analysis software. Given the small size of immunoselected DNA fragments, amplification products should preferably be no longer than 200–300 bp to facilitate detection. **Figure 3** shows a complete experiment analyzed by multiplex PCR using three primer pairs.

4. Notes

1. Use at least 100 mouse islets for each immunoprecipitation. Take into account that a complete experiment includes at least two immunoprecipitations (i.e., the antibody of interest and a control immunoprecipitation performed with nonimmune serum or an unrelated antibody). It is important to proceed to fixation shortly after isolation, as islets tend to aggregate with time, constituting large structures that become difficult to sonicate. Using small amounts of DNase (e.g., 0.1 mg/mL) during the pancreas digestion can also be necessary to prevent the formation of large islet clusters.
2. Fixation is one of the critical steps of the process. Thus, temperature and time need to be optimized for each new antibody tested (higher temperatures accelerate the process of fixation). A time-course experiment at room temperature is an advisable first step when testing a new antibody. Excess crosslinking can affect sonication quality of the samples and results in reduced antigen availability, thus interfering with the immunoprecipitation step. Ten minutes at room temperature represents a typical fixation condition.
3. Adjust resuspension volume according to islet number. Use about 150–200 μL for a minimum of 300–400 islets; otherwise, sonication is inefficient when smaller volumes are used. The volume can be increased to 300 μL if more tissue is used. Note that because the sample is later diluted 10-fold prior to immunoprecipitation, approx 50 μL of this solution corresponds to one immunoprecipitation reaction.
4. Effective sonication is essential for a successful ChIP assay. Sonication effectiveness depends on the quality of the sample, the extent of the fixation, the volume of the sample, and the sonication technique. The sonifier probe and the tube need to be in a firmly fixed position. Preliminary experiments may be needed to determine the optimal position of the probe tip relative to the liquid surface and the bottom of

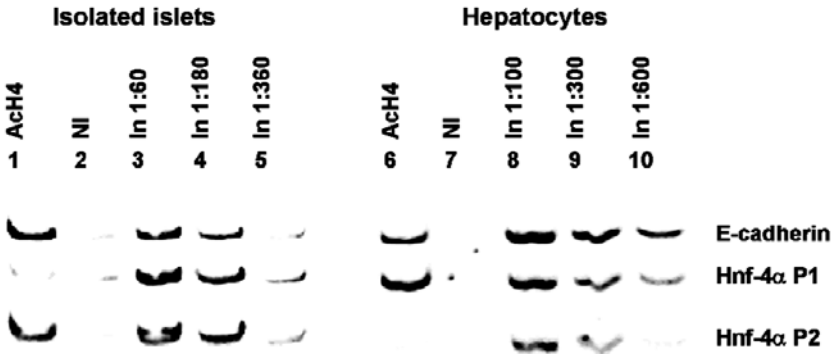

Fig. 3. Example of multiplex PCR analysis of a ChIP experiment using mouse isolated islets. Approximately 400 islets were processed as described in the text and divided in aliquots, so that 100 islets were immunoprecipitated with anti-tetra-acetylated histone H4 antibody (UBI) (ACh4). The selected DNA was analyzed by multiplex PCR and the results were compared to (1) the amplification pattern of the precipitation performed with a nonimmune serum (NI), corresponding to nonspecifically selected DNA, (2) the amplification of a series of dilutions of the *input* DNA, which reveals the expected amplification pattern in the absence of enrichment, and (3) the amplification pattern of the DNA selected by the antibody in another tissue—in this case, mouse hepatocytes. We used primers for a promoter known to be active in both islets and liver (E-Cadherin, positive control), a promoter active in liver but not in islets (*hnf-4α* P1 promoter, negative control), and a promoter active in islets but not in the liver (*hnf-4α* P2 promoter, our problem gene) (12). The results show that P2 but not P1 chromatin is hyperacetylated in islets, whereas the opposite pattern is observed in hepatocytes.

the tube to allow the most efficient sonication results without excessive foaming. We have found that for small volumes such as that required for islet cell experiments, sonication in buffers that do not contain SDS results in an excessive amount of high molecular-weight DNA. Overheating during the sonication process needs to be avoided as it can potentially result in crosslink reversal. Glass beads (1/5 volume) are used by some investigators to increase physical shearing of the DNA.

- High-salt buffer is commonly used, but low-salt buffer can be used to favor immunoprecipitation in cases when it is necessary (e.g., when working with limiting samples or when low specific enrichment is obtained with a particular antibody).
- Use preimmune serum, nonimmune IgGs, or unrelated serum, preferably against a non-nuclear protein. This negative control is intended to detect the DNA fragments that are nonspecifically precipitated by interacting with protein A or by forming aggregates. If saving material is an issue, this control may be avoided and the specificity of the precipitation may be checked by testing the presence or absence of specific DNA sequences in the precipitate. However, this is only feasible if appropriate positive and negative gene controls are known.

7. Alternatively, take an aliquot prior to immunoprecipitation, but this saves material if limiting. Note that this DNA cannot be used for checking the extent of sonication, as it contains salmon sperm DNA.
8. The volume of resuspension depends on the initial cell number. Resuspend in as small a volume as possible (e.g., 20–30 μL) and test PCR on undiluted and diluted samples. Generally, *input* DNA needs to be diluted a minimum of 50 times.
9. The purpose of coamplifying more than one amplicon is to ensure that the ChIP experiment has worked properly in all samples. Spurious carryover of DNA fragments (rather than enrichment as a result of specific antibody recognition) in some samples can occur, as well as sample-to-sample differences in the recovery of specifically immunoprecipitated chromatin. Intra-assay variation in PCR efficiency resulting from carryover of inhibitors can also occur. Using small amounts of tissue as starting material can increase the occurrence of such problems, leading to completely incorrect conclusions. In our view, the best way to overcome these problems is to ensure that the immunoprecipitated DNA exhibits a pattern of target amplification relative to negative and positive control segments that is consistently distinct from preimmune antibody precipitation and input DNA samples. This can be achieved with two sets of duplex DNA pairs or with a single triplex combination, as discussed in the protocol. Nonetheless, coamplification requires optimization of mutually compatible primer pairs. An alternative option is to run multiple parallel reactions with different primer pairs. Real-time PCR can be used to increase the ability to accurately quantitate small changes in target DNA.

The use of appropriate PCR controls as discussed here does not ensure that the DNA segments that have been enriched in the test antibody sample correspond solely to chromatin segments containing the intended epitope. Additional experiments are required to verify the specificity of the antibody under the immunoprecipitation conditions used. Ideally, this can be accomplished by comparison of control cellular sources that are known to either contain or lack the intended epitope. Some examples are cell lines that are transfected with a DNA-binding protein of interest versus a control vector, different tissues that are known to express or not such a protein, or a genetic null mutant model.

Acknowledgments

We thank Peggy J. Farnham and Ken Zaret for written unpublished protocols, Thierry Grange and Valerio Orlando for expert advice and organization of an EMBO course on *in vivo* protein–DNA interactions, and funding from JDRF (1–2002–21), EC (QLRT1999–546), and Ministerio de Ciencia y Tecnología (SAF01–2457).

References

1. Jones, K. A. and Kadonaga, J. T. (2000) Exploring the transcription–chromatin interface. *Genes Dev.* **14**, 1992–1996.

2. Jenuwein, T. and Allis, C. D. (2001) Translating the histone code. *Science* **293**, 1074–1080.
3. Hassan, A. H., Neely, K. E., Vignali, M., Reese, J. C., and Workman, J. L. (2001) Promoter targeting of chromatin-modifying complexes. *Front. Biosci.* **6**, D1054–D1064.
4. Narlikar, G. J., Fan, H. Y., and Kingston, R. E. (2002) Cooperation between complexes that regulate chromatin structure and transcription. *Cell* **108**, 475–487.
5. Solomon, M. J., Larsen, P. L., and Varshavsky, A. (1988) Mapping protein–DNA interactions in vivo with formaldehyde: evidence that histone H4 is retained on a highly transcribed gene. *Cell* **53**, 937–947.
6. Dedon, P. C., Soultis, J. A., Allis, C. D., and Gorovsky, M. A. (1991) Formaldehyde cross-linking and immunoprecipitation demonstrate developmental changes in H1 association with transcriptionally active genes. *Mol. Cell. Biol.* **11**, 1729–1733.
7. Orlando, V. (2000) Mapping chromosomal proteins in vivo by formaldehyde-crosslinked-chromatin immunoprecipitation. *Trends Biochem. Sci.* **25**, 99–104.
8. Breiling, A., Turner, B. M., Bianchi, M. E., and Orlando, V. (2001) General transcription factors bind promoters repressed by Polycomb group proteins. *Nature* **412**, 651–655.
9. Chaya, D., Hayamizu, T., Bustin, M., and Zaret, K. S. (2001) Transcription factor FoxA (HNF3) on a nucleosome at an enhancer complex in liver chromatin. *J. Biol. Chem.* **276**, 44,385–44,389.
10. Soutoglou, E. and Talianidis, I. (2002) Coordination of PIC assembly and chromatin remodeling during differentiation-induced gene activation. *Science* **295**, 1901–1904.
11. Parrizas, M., Maestro, M. A., Boj, et al. (2001) Hepatic nuclear factor 1-alpha directs nucleosomal hyperacetylation to its tissue-specific transcriptional targets. *Mol. Cell Biol.* **21**, 3234–3243.
12. Boj, S. F., Parrizas, M., Maestro, M. A., and Ferrer, J. (2001) A transcription factor regulatory circuit in differentiated pancreatic cells. *Proc. Natl. Acad. Sci. USA* **98**, 14,481–14,486.
13. Wells, J., Graveel, C. R., Bartley, S. M., Madore, S. J., and Farnham, P. J. (2002) The identification of E2F1-specific target genes. *Proc. Natl. Acad. Sci. USA* **99**, 3890–3895.
14. Katan-Khaykovich, Y. and Struhl, K. (2002) Dynamics of global histone acetylation and deacetylation in vivo: rapid restoration of normal histone acetylation status upon removal of activators and repressors. *Genes Dev.* **16**, 743–752.

FOR REFERENCE PURPOSES ONLY

Adenoviral Gene Transfer into β -Cell Lines

Amber L. Mosley and Sabire Özcan

1. Introduction

The proper functioning of the insulin-producing β -cells in the pancreas depends on the action of various proteins whose function and level of expression are tightly regulated in order to maintain a well state. Alterations in these processes can lead to diseased states such as diabetes mellitus. In order to understand the complexity of these processes, it is imperative that scientists can alter the levels of expression of various genes in order to define their role in maintaining β -cell function. This can be accomplished through multiple techniques, of which the adenoviral gene transfer is the most efficient one. Gene-transfer techniques utilizing recombinant adenoviruses have become an important tool in controlling the expression level of genes of interest (1). Adenoviral gene transfer is also important in gene therapy of many inherited disorders (2). Recombinant adenoviruses are commonly used for the overexpression of transgenes and can also be used to downregulate genes of interest through the expression of antisense ribozymes and Cre-recombinase (1,2).

1.1. Delivery of Genes into Insulinoma Cell Lines

Although there are multiple ways to deliver genes of interest to mammalian cells, many studies require in addition to efficient gene transfer into target cells, high-level, long-lasting, tissue-specific and/or regulated transgene expression. This is to be achieved in the absence of a toxic response to either viral functions or to the expressed protein. Transfection methods such as Ca_2PO_4 coprecipitation, electroporation, and lipofection result in a low amount of gene transfer to

a population of cells, normally ranging from 2% to 50%. Of the viral vectors (for review, *see ref. 1*), gene transfer by recombinant adenoviruses is a good choice for introduction of genes of interest into insulinoma cell lines (2). Using recombinant adenoviruses, a large number of cell types can be infected, including insulinoma cell lines and islets of Langerhans. Recombinant adenoviruses can easily be grown to very high titers and their efficiency of gene transfer into cultured cells is almost 100%.

1.2. Selection of Adenoviral Vectors

Adenoviral gene transfer has become a common way to introduce genetic information to cultured cells. One of the reasons for this is the ease of construction of adenoviral vectors. The majority of adenoviral vectors allow for the insertion of target genes through the deletion of adenoviral genes. The development of these vectors has been documented previously and will not be reviewed in detail here (for review, *see refs. 3 and 4*). In brief, the first generation of vectors arose from the removal of the adenoviral E1 and/or E3 genes (5). The E1 gene product of the adenovirus is essential for viral replication, and deletion of the E1 gene renders the adenovirus replication defective. The E3 gene is expendable in cultured cells because it allows the virus to evade the host immune system. This generation of vectors has been widely used and will be employed in the experiments that follow. Second-generation vectors were devised through deletion of some or the entire E2 gene that provides the machinery for viral replication. The third generation of vectors covers a broad range of vectors where various other genes are deleted. This generation includes what are known as “gutless” vectors where nearly all of the viral genes are removed (4). These various vectors can accept up to 5.6 kb of DNA and are easy to construct (for review, *see refs. 4 and 6*). When choosing a vector, it is important to select a promoter that will lead to the desired expression level of the protein of interest. Many of these vectors contain the promoter from the human cytomegalovirus (CMV) because it is fairly active and small in size (380 bp). Another type of vector that may be of interest expresses Bcl-2 both with and without NF- κ B inhibitors. These vectors are useful for expressing transgenes that may be toxic when expressed at high levels. These vectors help to prevent apoptosis and have been shown to increase the length of transgene expression (6,7).

1.3. Adenoviral Gene Transfer into Insulinoma Cell Lines

In order to optimize the infection of insulinoma cell lines, it is important to test the efficiency of each constructed recombinant adenovirus individually. Efficiency of gene transfer can vary based on the stability and toxicity of the expressed gene product itself in insulinoma cells. The adenoviral gene transfer

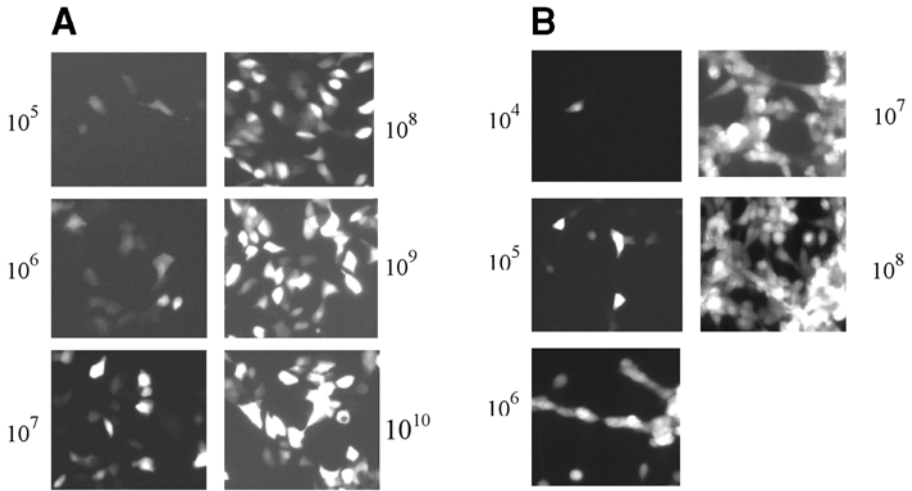

Fig 1. Analysis of the infection efficiency using different titers of the *GFP* adenovirus. (A): MIN6 cells infected with various titers of the *GFP* adenovirus. The adenoviral titer is given next to each panel. After the addition of the various concentrations of the adenovirus, plates were incubated for 1 h at 37°C with gentle agitation and then placed in a 37°C humidified incubator with 10% CO₂ for an additional 17 h. (B): INS-1 cells infected with various titers of the *GFP* adenovirus. The infection procedure is the same as described in (A).

method described in this chapter is optimized for use with the pAdEasy adenovirus system (8).

Infection of a confluent mouse insulinoma (MIN6) cell line (approx 1×10^6 cells) with different titers of a recombinant adenovirus that only expresses GFP [obtained after recombination of pAdTrackCMV and pAdEasy-1 vectors in bacteria (8)] resulted in infection of 85% of cells using an adenoviral titer of 1×10^8 plaque-forming unit (pfu)/mL (see Fig. 1A). This corresponds to a MOI (multiplicity of infection) of 100. Concentrations of virus greater than or equal to 1×10^9 resulted in very high GFP expression but appeared to be toxic to MIN6 cells with more than 20% of the cells detaching from the plate. The infection efficiency for the rat insulinoma-1 (INS-1) cells (approx 2×10^5 cells) with the *GFP* adenovirus was close 100% using an adenoviral titer of 1×10^7 pfu/mL, corresponding to a MOI of 50 (Fig. 1B). Increasing the adenoviral titer does not necessarily result in linear increases in protein expression levels, as shown in Fig. 2. The infection efficiency can be increased not only by using higher adenoviral titers but also by prolonging the length of infection. When using an adenoviral titer of 1×10^7 pfu/mL, MIN6 cells display maximal infection efficiency when they are exposed to the *GFP* adenovirus for 18 h. INS-1 cells also give

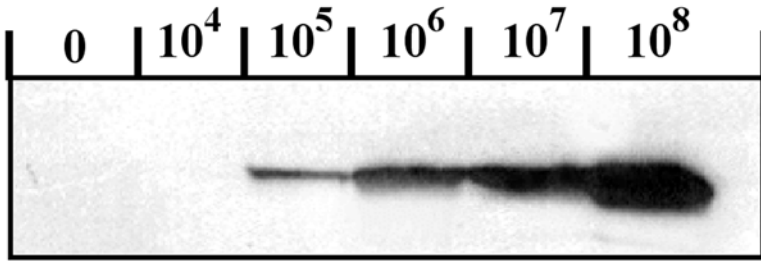

Fig. 2. Western blot analysis of *GFP* protein levels in MIN6 cell extracts infected with the *GFP* adenovirus using a monoclonal anti-GFP antibody (Clontech). The adenoviral titer used for infection of the MIN6 cells is given above each lane.

maximal infection efficiency with a titer of 1×10^6 pfu/mL when exposed to it for 18 h. Exposure of either cell line to the given concentrations of virus for 24 h did not result in increased infection, but in both cases, it leads to the detachment of more than 20% of the cells. These experiments show that although MIN-6 and INS-1 cells are both insulinoma cell lines, they display different infection efficiencies. Maximal infection of INS-1 less requires about 10-fold less virus than MIN-6 cells

2. Materials

2.1. Amplification of the GFP Adenovirus in HEK 293 Cells

1. Tissue culture dishes of 6 cm, 10 cm, and 15 cm diameter and sterile cell scrapers; 15-mL and 50-mL conical tubes.
2. Growth medium for HEK 293 cells: minimal essential medium (MEM) containing 5% fetal bovine serum (FBS) (Sigma), 2 mM glutamine, 50 μ M streptomycin/penicillin was sterilized through a 0.2- μ m filter.
3. 0.05% Trypsin-0.53 mM EDTA 4Na.
4. 1X Phosphate-buffered saline (PBS): 150 mM NaCl, 2.7 mM KCl, 4.3 mM Na_2HPO_4 , 1.4 mM KH_2PO_4 (pH 7.4); sterilize through a 0.2- μ m filter and store at 4°C.
5. Dry ice/methanol bath and 37°C water bath.

2.2. Preparation and Infection of Insulinoma Cell Lines

1. Dulbecco's modified Eagle's media (DMEM) with 4.5 g/L glucose. For MIN6 cells, add 10% FBS (Hyclone), 2mM glutamine, 50 μ M streptomycin/penicillin, and 3.5 μ M β -ME (see **item 3**) and sterilize through a 0.2- μ m filter. Warm to 37°C before use. Store at 4°C.
2. RPMI-1640 with L-glutamine. For INS-1 cells, add 10% FCS (Sigma), 2mM glutamine, 50 μ M streptomycin/penicillin, and 50 μ M β -ME and sterilize through a 0.2 μ m-filter. Warm to 37°C before use. Store at 4°C.

3. β -mercaptoethanol (β -ME), cell culture grade (Sigma). Store at 4°C.
4. Fetal calf serum (FCS, Sigma). Thaw FCS at 37°C water bath and heat to 56°C for 30 min and aliquot into 50-mL conical tubes prior to use.
5. L-Glutamine. Store at -20°C. Thaw at 37°C before use.
6. Streptomycin/penicillin. Store at -20°C. Thaw at 37°C before use.

3. Methods

3.1. Amplification of the GFP Adenovirus in HEK293 Cells

1. After recombination of the pAdTrackCMV with the pAdEasy-1 vector in bacteria, the recombinant adenoviral plasmid DNA was used to transfect the human embryonic kidney (HEK293) cells in 6-cm tissue culture dishes using lipofectamine (Invitrogen) (see **Notes 1–4**).
2. After 2 wk, lysis is observed and the cells are scraped off and collected in 15-mL conical tubes.
3. After centrifugation of the cells at 2000g for 10 min, the pellet is resuspended in 2 mL MEM.
4. The resuspended cells are immediately subjected to four cycles of freezing–thawing. Cells are frozen in dry ice/methanol bath and thawed in a 37°C water bath.
5. Spin down the cell debris by centrifuging at 5000g for 10 min, transfer the supernatant into a 15-mL conical tube, and store at -20°C.
6. The obtained adenoviruses are further amplified by using 400 μ L (20%) of the obtained viral supernatant to infect a 10-cm dish of 80% confluent HEK293 cells. After 3–5 d postinfection (when about 50% of the cells are detached), the cells are harvested and lysed by four cycles of freezing–thawing (**steps 4–6**) (see **Note 5**).
7. About 500 μ L of the viral supernatant obtained in **step 6** is used to infect a 15-cm dish of 80% confluent HEK293 cells for further amplification of the GFP virus used in this study (see **Notes 6 and 7**).

3.2. Preparation of Insulinoma Cell Lines

1. Count the number of cells using a hemocytometer and reseed MIN6 cells at a density of 5×10^5 and 1×10^5 for INS-1 cells in tissue culture dishes with a 35-mm diameter.
2. Bring the total volume to 2 mL with DMEM plus 10% FBS for MIN6 cells and RPMI plus 10% FCS for INS-1 cells. Feed cells the next day by aspirating the media and replacing it with fresh media.
3. Continue to feed them every other day until they reach 80% confluency.

3.3. Infection of the Insulinoma Cell Lines

1. Remove the virus aliquots from the freezer (-20°C), allowing them to thaw on ice.
2. In a tissue culture hood, aspirate the media and rinse the cells twice with 2 mL of 1X PBS (see **Note 8**).
3. Mix the desired amount of adenoviral supernatant with 600–1000 μ L of serum-free DMEM for MIN6 cells and RPMI for INS-1 cells. Transfer the adenovirus mixture

to each plate. Make sure that the cells on the plate are completely covered with media (*see Note 9*).

4. In order to ensure an even distribution of virus, incubate the cells with the virus for 1 h at 37°C with gentle agitation.
5. Add 1 mL of DMEM plus 20% FBS for MIN6 cells and RPMI with 20% FCS to INS-1 cells. The final concentration of serum is 10%. Return the plates to the 37°C CO₂ incubator. Incubate for 18 h (*see Note 10*).
6. Replace the virus mixture with 2 mL DMEM plus 10% FBS for MIN6 cells and RPMI with 10% FCS for INS-1 cells with serum to a total volume of 2 mL. Allow the infection to proceed for 48 h in order to achieve maximum protein expression.

4. Notes

1. The HEK293 cell line used in this study was obtained from Quantum Biotechnologies Inc. and was grown on DMEM media with 5% FBS. For 6-cm, 10-cm, and 15-cm culture dishes, the amount of media used was 5 mL, 10 mL, and 25 mL, respectively.
2. The pAdEasy adenoviral expression system used in this study is described in detail at <http://www.coloncancer.org/adeasy/protocol.htm> and in ref. **8**. The adenoviral system described here lacks the E1 gene that is required for replication. Therefore, the obtained recombinant adenoviruses need to be amplified in HEK293 cells, which express the E1 gene and facilitate the amplification of the virus.
3. Lipofectamine transfection was carried out according to the manufacturer's (Invitrogen) protocol and a description of this transfection technique can be found in Chapter 5 of this volume.
4. Although we used for infection of β -cell lines the GFP adenovirus here, the same conditions apply also for infection with other recombinant adenoviruses containing β -cell-specific genes such as the pancreas-specific transcription factor PDX-1.
5. This step should yield about 10⁶–10⁷ pfu/mL. At this point, the presence of the recombinant adenovirus can be checked either by polymerase chain reaction (PCR) or by immunoblotting with specific antibodies.
6. We have obtained 4 mL of viral supernatant with a titer of about 1 × 10⁹ pfu/mL from six 15 cm of 80% confluent HEK293 cells infected with the GFP adenovirus. The viral titer is determined by infecting confluent HEK293 cells with a 1 : 10,000 dilution of the concentrated GFP adenovirus for 18–24 h, as described previously (**9**). After this incubation period, the number of GFP-positive cells per field is counted three times using 100× magnification. The average number of GFP-positive cells is multiplied by 10⁷ and the obtained number is defined as plaque-forming units per milliliter. This number should be proportional to the number of infective viral particles in the amplified adenoviral preparation.
7. For decontamination of recombinant adenoviruses, dishes, pipets, and tubes were rinsed with 10% bleach and autoclaved.
8. The high level of protein in the DMEM + 10% FBS and RPMI + 10% FCS can interfere with the binding of the adenovirus particles to their cellular receptors. For

this reason, washing with 1X PBS is critical to the infection process as well as the use of a serum-free media during the infection.

9. The amount of virus needed will be dependent on the cell type. For β -cell lines, a MOI of 30–100 (30–100 virus particles per cell) is a good starting point.
10. The length of infection time will be dependent on the cell type as well as the gene that is being introduced.

Acknowledgment

This work was supported by a Juvenile Diabetes Research Foundation (JDRF) grant to SÖ.

References

1. Russell, W. C. (2000) Update on adenovirus and its vectors. *J. Gen. Virol.* **81**, 2573–2604.
2. Kochanek, S. (1999) High-capacity adenoviral vectors for gene transfer and somatic gene therapy. *Hum. Gene Ther.* **10**, 2451–2459.
3. Zhang, W. W. (1999) Development and application of adenoviral vectors for gene therapy of cancer. *Cancer Gene Ther.* **6**, 113–138.
4. Tashiro, F., Niwa, H., and Miyazaki, J. (1999) Constructing adenoviral vectors by using the circular form of the adenoviral gene cloned in a cosmid and the Cre-loxP recombination system. *Hum. Gene Ther.* **10**, 1845–1852.
5. Bilbao, G., Contreras, J. L., Zhang, H. G., Pike, M. J., Overturf, K., Mikheeva, G., et al. (1999) Adenovirus-mediated gene expression in vivo is enhanced by the anti-apoptotic bcl-2 gene. *J. Virol.* **73**, 6992–7000.
6. Antinozzi, P. A., Berman, H. K., O'Doherty, R. M., and Newgard, C. B. (1999) Metabolic engineering with recombinant adenoviruses. *Annu. Rev. Nutr.* **19**, 511–544.
7. de Moissac, D., Zheng, H., and Kirshenbaum, L. A. (1991) Linkage of the BH4 domain of Bcl-2 and the nuclear factor kappaB signaling pathway for suppression of apoptosis. *J. Biol. Chem.* **274**, 29,505–29,509.
8. He, T. C., Zhou, S., da Costa, L. T., Yu, J., Kinzler, K. W., and Vogelstein, B. (1998) A simplified system for generating recombinant adenoviruses. *Proc. Natl. Acad. Sci. USA* **95**, 2509–2514.
9. Kaneto, H., Xu, G., Song, K. H., Suzuma, K., Bonner-Weir, S., Sharma, A., et al. (2001) Activation of the hexosamine pathway leads to deterioration of pancreatic beta-cell function through the induction of oxidative stress. *J. Biol. Chem.* **276**, 31,099–31,104.

FOR REFERENCE PURPOSES ONLY

Utilization of NOD Mice in the Study of Type 1 Diabetes

Dennis G. Karounos and Susan E. Goes

1. Introduction

Animal models of type 1 diabetes provide excellent tools for investigators to evaluate the pathogenesis, metabolic effects, and complications of type 1 diabetes. These models have many features of human type 1 diabetes with some important exceptions that will be pointed out in this chapter. The animal models include both spontaneous disease models as well as induced diabetes such as streptozotocin-induced diabetes. One of the most widely used spontaneous disease models is the inbred nonobese diabetic (NOD) mouse model. Investigators in Japan derived the NOD mouse line during inbreeding studies to produce a cataract-prone strain, designated CTS (*I*). This spontaneous cataract mouse model was derived from the outbred ICR mouse line. During their studies, they noted that a mouse had spontaneous hyperglycemia. They did brother–sister matings of some of the cataract-free mice that had either high or low fasting plasma glucoses. Paradoxically, the diabetic mice were derived from the low-fasting-glucose line and a diabetes-resistant mouse, NON, was derived from the high-fasting-glucose line. The NON mouse, genetically similar to the NOD mouse, served as a nondiabetic control mouse strain. The NOD mice have been used widely as a mouse model of type 1 diabetes for the past 20 yr. These mice have a T-cell-mediated diabetes and share many of the classic features of type 1 diabetes, including the presence of lymphocytic infiltration of the islets present prior to the onset of clinical diabetes, insulinopenia, hyperglycemia, polyuria, and weight loss (*I*). They also develop ketosis, and after several weeks of clinical diabetes, they will

die if not treated with insulin. Unlike human diabetes, there is a higher incidence of diabetes in females compared to males. In this inbred strain of mice, the incidence of diabetes is influenced by environmental factors (2). The mice require special handling to ensure that they will develop spontaneous diabetes. They must be housed in a specific pathogen-free animal facility to develop diabetes. If they are exposed to infections such as mouse hepatitis virus, they do not develop diabetes. In addition, exposure to immune stimulants such as complete Freund's adjuvant also prevent diabetes (3). In contrast, administration of an alkylating agent, cyclophosphamide, accelerates the development of diabetes, presumably by decreasing the regulatory T-cell population (4,5). This chapter describes, in detail, animal care techniques, diagnosis of diabetes, phlebotomy, insulin therapy, breeding, glucose tolerance testing, insulin assays, and adoptive transfer. These techniques allow investigators to exploit the full potential of this animal model for studies of pathogenesis and complications of type 1 diabetes.

2. Materials

2.1. Reagents

1. NOD mice can be obtained as NOD/Mrk (Taconics, Germantown, NY [<http://www.taconic.com>]) or NOD/Lt (Jackson Lab, Bar Harbor, ME [<http://www.jax.org>]). (See **Note 1**.)
2. Water bottles, acidified water: Water should be acidified to pH 2.8–3.2 with hydrochloric acid to prevent *Pseudomonas* growth or autoclaved for 20 min at 250°C.
3. Autoclaved or irradiated mouse chow (Purina 5001, or Harlan Teklad Global 18% Protein Rodent Diet #2918, <http://www.teklad.com/>).
4. Urine glucose (Diastix, Miles Lab) and ketone test strips (Ketostix, Miles Lab).
5. Blood glucose test strips (Bayer Elite).
6. Glucose meter calibration solution.
7. Human insulin NPH U-100 (Novo or Lilly).
8. NPH insulin diluent: Sodium phosphate 20 mM, pH 7.0–7.4, phenol 0.065%, m-Cresol 0.16%, glycerol 1.6%, protamine sulfate 0.3–0.6 mg/dL; for 100 mL add: 20 mL of 100 mM sodium phosphate, 0.0653 mL phenol, 0.16 mL glycerol, 5 mg protamine sulfate, water to final volume of 100 mL.
9. Disinfecting solution (Spor Klensz, 1%, Steris Corporation, Calgon Vestal Division, 8525 Page Avenue, St. Louis, MO).
10. Halothane (USP: Halocarbon Products Corp, 120 Dittmen Ct, North Augusta, SC).
11. Rat Insulin ELISA Mercodia assay kit (ALPCO, Windham, NH, www.alpco.com).
12. Rodent insulin RIA kit (Linco, St. Louis, MO).
13. Cyclophosphamide (Sigma Chemical Company, St. Louis, MO).
14. PZI Beef and Pork Insulin (BRI Bluebridge Pharmaceuticals Inc.).
15. Paraformaldehyde.
16. Hematoxylin and eosin.

2.2. Equipment

1. Microisolater cages (Lab Products, Inc., 742 Sussex Ave., Seaford, DE).
2. Glucose meter (Bayer Elite XL: <http://www.glucometerstore.com/> and <http://www.bayercarediabetes.com/prodserv/products/glucEliteXL/index.asp>).
3. Microhematocrit capillary tube.
4. Sponge gauze.
5. Scalpel with fine #11 blade.
6. Insulin syringe with 27-gauge needle.
7. Heparinized capillary tube for plebotomy.
8. HEPA-filtered laminar-flow workbench.

3. Methods

3.1. Animal Care

When handling the NOD mice, use the following procedures:

1. Wear laboratory coat, protective sleeves, gloves, and face mask.
2. All work is performed in a HEPA-filtered laminar-flow workbench. The surface is precleaned with sterilant (Spor Klenz, 1%).
3. For the mice to maintain a high incidence of spontaneous diabetes, they should be housed in a murine-specific pathogen-free animal facility. The cleaner the facility, the higher the incidence of spontaneous diabetes.
4. NOD mice are housed in microisolation housing units consisting of a plastic filter top, plastic cage (autoclavable, plastic preferable), stainless-steel wire bar lids, autoclaved water bottle with a rubber stopper, and stainless-steel sipper tube. Prior to use, the cages are sterilized by autoclaving or immersion in 1% Spor Klenz. Bedding is sterilized by autoclave for 20 min at 250°C followed by 5 min of drying time.
5. The water given to the NOD mice should be acidified to pH 2.8–3.2 with hydrochloric acid to prevent *Pseudomonas* growth or autoclaved for 20 min at 250°C.
6. The mouse chow should be autoclaved (Purina 5001 or equivalent), or use irradiation-sterilized mouse chow from Harland Teklad.

3.2. Diagnosis of Diabetes

1. To determine if the mice become diabetic, urine or blood glucoses should be monitored on a weekly basis beginning at 10 wk of age.
2. To obtain a urine glucose, lifting up the mice usually causes them to urinate. The drop of urine can be placed on the urine glucose strip. If the urine glucose is positive, the diagnosis of diabetes is confirmed if the blood glucose is greater than 300 mg/dL obtained for 2 wk in a row (*see Note 2*).

3.3. Accelerating the onset of Diabetes

NOD mice develop spontaneous diabetes between 20 and 50 wk of age. Investigators have found that administration of 1–2 doses of cyclophosphamide

can dramatically accelerate the onset of diabetes so that the peak onset of diabetes is 30–40 d rather than 30–40 wk (4) (see Note 3).

1. Cyclophosphamide is administered as a single ip injection, 100–300 mg/kg body weight, to mice older than 7 wk of age (4).
2. Mice are then monitored daily for glycosuria. Once glycosuria is detected, the diagnosis of diabetes is confirmed if blood glucoses are elevated greater than 300 mg/dL on 2 consecutive days.
3. The cumulative incidence of diabetes is determined 5 wk after cyclophosphamide treatment.

3.4. Phlebotomy

3.4.1. Monitoring of Blood Glucose Levels with a Glucose Monitor Strip

1. To monitor blood glucose, only a 5- μ L blood sample is needed and can be readily obtained by nicking the very tip of the tail with a sharp scalpel.
2. The blood is drawn by capillary action into the glucose monitor strip (Bayer Elite[®]).
3. The same area is nicked each week, which can be done with minimal discomfort to the animal with repeated blood sugar for up to 1 yr without shortening the tail.
4. Repeated samples should not be obtained on the same day, because after the initial sample, vasoconstriction will alter the subsequent samples. If a second glucose values is needed, blood should be obtained from an alternative site as described below.

3.4.2. Obtaining Blood Samples from the Retroorbital Sinus

1. Animals are anesthetized with halothane using a desiccator jar with a plastic grid raised 2 in. off the bottom to keep the animals from having direct contact with the halothane. For inhalation anesthesia, it is important to perform the procedure in a ventilated hood to prevent the staff's exposure to halothane. Place a clean 4 \times 4 gauze in the bottom of the jar and wet with several milliliters of halothane. Replace the grid above the wet gauze. Wait 15 min for the vapor pressure to build up.
2. Place one mouse at a time in the desiccator jar and observe them very closely. Initially, the mice will be hyperactive and then begin to develop a staggered gait. Monitor the respirations closely. If the breathing becomes slow or irregular or when the animal is inactive, remove it from the anesthesia.
3. Restrain the animal by securing the tail between the fourth and fifth fingers while holding the scruff of the neck with the index and forefinger. The neck should be held tight enough to constrict the neck veins, causing the eyes to bulge slightly but not to tight to stop respirations. This slight increase in venous pressure makes it much easier to obtain a blood sample.
4. The capillary tube is placed in the medial canthus of the orbit and rotated along the axial axis to initiate the blood flow. The opposite end of the tube is kept low to promote the capillary action. Approximately 100–300 μ L of blood can be safely obtained.

5. The eye is blotted with a clean gauze dampened with sterile saline or phosphate-buffered saline. With proper care, this technique can be done repeatedly without injuring the animal's eye. (See **Note 4**.)

3.4.3. Obtaining Blood Using Cardiac Puncture

In this technique we use cardiac puncture to obtain blood at the termination of experiments when the mice are killed. For this, we use CO₂ anesthesia. If it is necessary to obtain a blood glucose, it should be obtained prior to giving the CO₂ anesthesia, because the CO₂ will cause the blood glucose to be falsely elevated.

1. For the anesthesia, we keep the mice in the sealed plastic chamber and allow the CO₂ to flow in through the port on the top of the chamber until the mouse stops moving and the respirations are shallow but not completely stopped.
2. The mouse is removed from the chamber and the CO₂ is turned off to be sure to not expose the staff to excessive amounts of CO₂.
3. The mouse is placed on its back and the four legs immobilized by needles on a Styrofoam board.
4. The sternal notch is identified, and cardiac puncture is performed using a 1-in 23-gauge needle on a 1-mL syringe. The needle is inserted just left of the sternum at a 45° angle. Only a small amount of suction is applied to the syringe and the needle is move slowly in and out (without coming completely out of the skin) until the hub of the needle is filled with blood. The blood is slowly drawn into the syringe obtaining a sample between 0.5 and 0.8 mL.
5. The blood is then placed in a 1.5-mL microfuge tube and allowed to coagulate at 4°C for several hours. The sample is spun down in a microfuge, and the sera removed.

3.5. Insulin Therapy

For short-term studies, insulin therapy is usually not necessary and diabetic mice can live for 4 wk after diagnosis without insulin treatment. For long-term studies, mice can be treated with long-acting insulins such as PZI Beef and Pork Insulin.

1. Treat NOD mice with PZI Beef and Pork Insulin 0.5–1 U/d or NPH. For NPH insulin, we use human recombinant insulin diluted in insulin diluent 1:10 administered at a dose of 0.125–1.00 U/d (0.1 mL) using a 27-gauge needle in a 0.5-mL insulin syringe (see **Note 5**).
2. Monitor mice carefully for 2- to 4-h intervals after their NPH insulin dose or 6–12 h after their PZI insulin and treat hypoglycemia with dextrose (200 mg/mL in sterile 0.85% sodium chloride) given as an ip injection.

3.6. Insulinitis Grading

One of the hallmarks of type 1 diabetes is the development of insulinitis—lymphocytic infiltration of the islets. Grading the severity of the insulinitis is a useful

immunological parameter to monitor when evaluating immunological therapies or genetic influences.

1. Mice are killed by CO₂ inhalation. All four legs are pinned down on a Styrofoam board and the abdomen is cleaned with 70% ethanol.
2. Using forceps, an incision through the fur but not into the peritoneal cavity is made just below the sternum and extended bilaterally to the back. The fur is pulled upward and backward at the incision, exposing the abdominal wall. Any fur is washed away with the ethanol spray bottle.
3. An incision is made just below the sternum, exposing the liver and stomach.
4. The pancreas is just below the stomach with the tail of the pancreas attached to the spleen and the head of the pancreas is attached at the common bile duct near the ligament of Tritz. The spleen is the best landmark for finding the pancreas. Locate the spleen while approaching the abdomen from the left flank just above the kidney.
5. Carefully remove the spleen and you will see the tail of the pancreas attached to the right side of the spleen. The pancreas is somewhat darker yellow than the adipose tissue.
6. The pancreas is removed and fixed in 4% neutral-buffered paraformaldehyde and stained with hematoxylin and eosin and sectioned at three nonoverlapping levels.
7. Six to 10 islets per mouse were individually scored by two independent observers using a semiquantitative scale ranging from 0 to 4: 0, normal islet with no sign of T-cell infiltration; 1, islet associated with perivascular, periductal leukocytic infiltration only; 2, more extensive peri-islet infiltration but with lymphocytes with less than 25% islet destruction; 3, >25% islet destruction; 4, complete islet destruction (6).
8. An insulinitis score for each mouse was obtained by dividing the total score for each mouse by the number of islets examined (6).

3.7. Breeding

Some investigators prefer to breed their own mice rather than purchase the necessary number of animals for each experiment (*see Note 6*).

1. Avoid random breeding.
2. Place males in a cage for breeding and allow them to acclimate for 2–3 d prior to breeding.
3. Always introduce females into the males' cage—two females for every male.
4. Do not disturb the litter for at least 7 d after birth.
5. Avoid excessive noise and do not handle the newborn or parents for the first 6 wk.
6. When a mother becomes diabetic, she will stop nursing her babies.
7. Monitor for development of diabetes in breeders by holding mouse until they urinate and then test the urine as described in **Subheading 3.2**.
8. To maintain a foundation colony, do only brother–sister matings. Careful pedigree records will have to be maintained to keep the foundation colony.

9. Random breeding can be done for three generations, but not longer. Otherwise, the polygenic diabetes trait will be lost. If more than three generations are maintained, the investigator will have to verify that the genetic integrity of the inbred line is being maintained.

3.8. Glucose Tolerance Testing

To assess glucose tolerance, a useful test is to determine the insulin or C-peptide response to intraperitoneal glucose. The intraperitoneal glucose tolerance gives a useful approximation of β -cell reserve.

1. Mice are fasted overnight (17 h).
2. The blood glucose level is checked at baseline and again 4 min after administering glucose. Only the initial blood sample can be obtained by tail-tip wound, because the mice develop vasoconstriction of the tail after the initial blood sample, which will interfere with the second blood sample. Blood glucose is determined with a reflectance meter using the initial 25 μ L of blood collected from the tail.
3. Glucose (200 mg/mL in 0.85% sodium chloride) in 1-mL syringes were prewarmed to 40° C and mice injected ip at 3 g/kg body wt.
4. The second blood glucose is determined 4 min after administering glucose. This sample is collected into microhematocrit capillary tubes from the retroorbital sinus of an anesthetized mouse. From this sample, 10 μ L of blood is used to determine the blood glucose level using the Glucometer Elite. The remaining 100–200 μ L of blood is collected into a microfuge tube and the serum separated for insulin or C-peptide determination. Insulin levels is determined using a rodent radioimmunoassay (RIA) kit per manufacturers' instructions or an enzyme-linked immunoassay (ELISA).

3.9. Assaying Insulin Levels Utilizing an Enzyme-Linked Immunoassay

Because the rodent insulin sequence is identical for rats and mice, the rat assay kits are used for both insulin and C-peptide measurements (*see Note 7*)

1. Collect blood by venopuncture and allow to clot.
2. Centrifuge for separation of sera (*see Note 8*).
3. Prepare 96-well plate for standards, controls, and samples to be run in duplicate. Pipet 25 μ L each of standards, controls, and samples into designated wells (*see Note 9*).
4. Add 50 μ L peroxidase-conjugated mouse monoclonal anti-insulin working solution to each well.
5. Incubate at room temperature for 2 h, then wash.
6. Add 200 μ L of TMB (tetramethylbenzidine) peroxidase solution to the wells and incubate for 15 min at room temperature. Keep plate out of direct light during this phase (*see Note 10*).

7. Stop the reaction by adding the Stop Solution to each well and read at an optical density (OD) of 450 nm on a spectrophotometer.

3.10. Adoptive Transfer

The adoptive transfer technique is not only an accelerated model of spontaneous diabetes but it also allows the investigator to evaluate the cellular and genetic components involved in the immunopathogenesis of diabetes. As an accelerated model of diabetes, recipient mice develop diabetes 4–12 wk after transfer of donor cells compared to 20–40 wk of age in the spontaneous disease models (7–9). The critical factors are to maintain a genetically susceptible host and to give adequate numbers of donor lymphocytes to induce diabetes. The NOD/SCID (Jackson Laboratories) is an ideal host because these immune-deficient mice lack both B-cells and T-cells but carry all the diabetes-susceptibility genes of the NOD/Lt mice (10).

1. Diabetic donor mice were chosen that had blood glucoses greater than 300 mg/dL. Administration of spleen cells to NOD/Lt-SZscid/scid should induce diabetes in all recipient mice within 4–6 wk. This group serves as a positive disease control group.
2. To evaluate possible immune suppressive therapy, donor mice are pretreated with test agent for at least 4–8 wk. Non-diabetic donors were chosen from the treated mice that were healthy for their age and with glucoses under 200 mg/dL by glucose meter. These animals were sacrificed by CO₂ inhalation. Blood was then drawn by cardiac puncture and can be saved for later experiments.
3. Using strict sterile technique, remove spleens and lymph nodes from donor groups and process the tissues for T-cells to be injected into the recipient mice by IP injection.
4. We use approximately six NOD/LtSZscid/scid recipient mice in each treatment group.
5. We prefer to inject donor cells by intraperitoneal injection, but intravenous injection of cells in the tail vein of the restrained donor animal with some practice.

4. Notes

1. Nonobese-diabetic mice can be obtained from two suppliers in the United States, The Jackson Laboratory or Taconics. If the studies involve evaluation of spontaneous diabetes incidence, mice should be older than 4–6 wk of age prior to shipping the mice. Shipping younger mice can reduce the spontaneous incidence of diabetes. We allow the mice to acclimate to our facility for 4 wk before initiating any experiments.
2. Occasionally, a mouse will have a transient hyperglycemia, so it is important to get at least two blood glucose measurements.
3. It is believed that the cyclophosphamide selective destroys suppressor cells, leaving pathogenic T-cells unopposed to accelerate the onset of diabetes (5).
4. This technique is used when larger samples of blood need to be drawn.

5. For younger mice to avoid hypoglycemia, this dose may have to be reduced by 50% until their body weight reaches 22–25 g.
6. To maintain a foundation colony, breed the mice only by brother–sister matings. Careful pedigree records will have to be maintained to keep the foundation colony. If your studies involve young adult mice, when you consider the per-diem costs, it is usually more cost-effective to purchase the mice from the suppliers. If the NOD mice will be used for studies of neonatal mice, it is sometimes necessary to breed your own mice. Another consideration is that if the mice are shipped at a very young age from the suppliers, we find that the spontaneous rate of diabetes is lower. Thus, for experiments involving very young mice, it is necessary to breed your own mice.
7. We have also readily obtained excellent results using the RIA kits from Linco (St. Louis, MO). To avoid radioactivity in recent years, we have switch to the enzyme-linked immunoassays (ALPCO).
8. Sera can be stored at 2–8°C up to 24 h or can be frozen at –20°C. Avoid repeated freezing and thawing of samples.
9. The ALPCO Rat Insulin ELISA is a solid-phase two-site enzyme immunoassay.
10. Most of the reagents used in this assay are delivered with the kit.

References

1. Makino, S., Kunimoto, K., Muraoka, Y., Mizushima, Y., Katagiri, K., and Tochino, Y. (1980) Breeding of a non-obese, diabetic strain of mice. *Jikken Dobutsu* **29**, 1–13.
2. Leiter, E. H., Serreze, D. V., and Prochazka, M. (1990) The genetics and epidemiology of diabetes in NOD mice. *Immunol. Today* **11**, 147–149.
3. Sadelain, M. W., Qin, H. Y., Lauzon, J., and Singh, B. (1990) Prevention of type I diabetes in NOD mice by adjuvant immunotherapy. *Diabetes* **39**, 583–589.
4. Charlton, B., Bacelj, A., Slattery, R. M. and Mandel, T. E. (1989) Cyclophosphamide-induced diabetes in NOD/WEHI mice. Evidence for suppression in spontaneous autoimmune diabetes mellitus. *Diabetes* **38**, 441–447.
5. Yasunami, R. and Bach, J. F. (1988) Anti-suppressor effect of cyclophosphamide on the development of spontaneous diabetes in NOD mice. *Eur. J. Immunol.* **18**, 481–484.
6. Serreze, D. V., Leiter, E. H., Christianson, G. J., Greiner, D., and Roopenian, D. C. (1994) Major histocompatibility complex class I deficient Nod–B2M (null) mice are diabetes and insulinitis resistant. *Diabetes* **43**, 505–509.
7. Haskins, K., Portas, M., Bergman, B., Lafferty, K., and Bradley, B. (1989) Pancreatic islet-specific T-cell clones from nonobese diabetic mice. *Proc. Natl. Acad. Sci. USA* **86**, 8000–8004.
8. Serreze, D. V., Leiter, E. H., Worthen, S. M., and Shultz, L. D. (1988) NOD marrow stem cells adoptively transfer diabetes to resistant (NOD × NON) F1 mice. *Diabetes* **37**, 252–255.

9. Wicker, L. S., Miller, B. J., and Mullen, Y. (1986) Transfer of autoimmune diabetes mellitus with splenocytes from nonobese diabetic (NOD) mice. *Diabetes* **35**, 855–860.
10. Serreze, D. V., Leiter, E. H., Hanson, M. S., Christianson, S. W., Shultz, L. D., Hesselton, R. M., et al. (1995) Emv30null NOD–scid mice. An improved host for adoptive transfer of autoimmune diabetes and growth of human lymphohematopoietic cells. *Diabetes* **44**, 1392–1398.

Introduction of DNA into 3T3-L1 Adipocytes by Electroporation

Shuichi Okada, Masatomo Mori, and Jeffrey E. Pessin

1. Introduction

After cloning a gene of interest, many researchers wish to analyze its characteristics by overexpression analysis or by introduction of mutated forms of the gene of interest into various cell types. In the analysis of insulin-stimulated glucose transport, the most appropriate cell systems are striated muscle and adipocytes (**1**). However, the introduction of DNA or genes of interest into these insulin-responsive tissues by standard transfection protocols such as calcium phosphate, DEAE-dextran, and liposome-mediated transfection are very inefficient. Furthermore, although transgenes can be expressed in muscle using adenovirus infection systems, this is difficult to accomplish in adipocytes and is substantially more labor intensive. The production of recombinant adenoviruses to use in infection of insulin-responsive tissues can take several months and requires very high titers of adenovirus. Therefore, we have recently established electroporation conditions that consistently provide at least 50% transfection efficiency for cultured differentiated 3T3-L1 adipocytes (**2**). Although the electroporation is not 100% efficient, it provides an easy and fast method to introduce DNA into adipocytes. Using 600 μg of CMV-LacZ plasmid DNA, we consistently obtain an electroporation efficiency of 50–80% (see **Fig. 1**).

2. Materials

1. Equipment: Gene Pulser (Bio-Rad).
2. Phosphate-buffered saline (PBS): 150 mM NaCl, 2.7 mM KCl, 4.3 mM Na_2HPO_4 , 1.4 mM KH_2PO_4 (pH 7.4); sterilize through a 0.2- μm filter and store at 4°C.

 μg **LacZ****0****600**

Fig. 1. Electroporation efficiency of adipocytes tested using pcDNA3.1-LacZ. Differentiated 3T3L1 adipocytes were electroporated with 0 or 600 μg of pcDNA3.1-LacZ, and transfection/expression efficiency was determined by X-Gal staining for β -galactosidase expression.

3. Complete medium: Dulbecco's modified Eagle's medium (DMEM) plus 10% fetal bovine serum (FBS).
4. Dulbecco's PBS without Mg^{2+} or Ca^{2+} (D-PBS) (Gibco-BRL, cat. no. 14190-029).
5. 15- and 50-mL conical tubes.
6. Tube rack.
7. Timer.
8. Cuvet.
9. Cuvet stand.
10. Collagen-4 coated six-well plates (Fisher Scientific, prewarmed at 37°C).
11. Plasmid DNA (CsCl doubled banded).
12. Trypsin-EDTA (0.05% or try 0.25% solution). Warm to room temperature prior to use.

3. Methods

3.1. Preparation of the Adipocytes for Electroporation

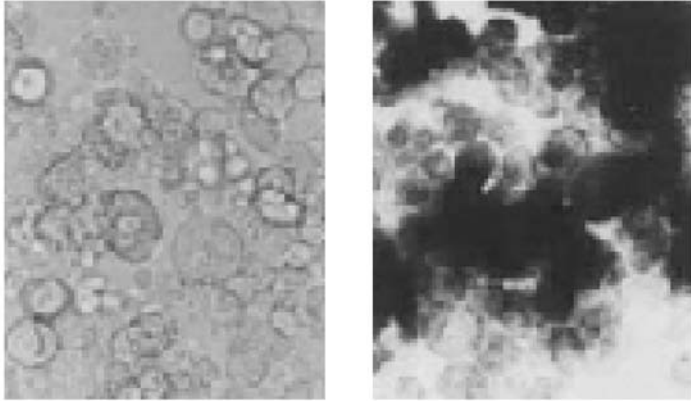
1. Differentiated 3T3-L1 adipocytes are grown on 15-cm tissue culture dishes as previously described (**1**) (see **Note 1**). Wash the cells with 20 mL of 1X PBS, then add 6 mL of trypsin-EDTA solution, and swirl gently.
2. Remove the trypsin-EDTA solution by aspiration and warm the cells for 10 min at 37°C by placing them in a tissue culture incubator.
3. Add 3 mL of complete media and pipet up and down 10 times in order to remove cells from culture dish and to disperse cell clumps (see **Note 2**).

4. Transfer the suspended cells to a 50-mL conical tissue culture centrifuge tube. Centrifuge the cell suspension for 5 min at approx 180g at room temperature.
5. Carefully remove all of the supernatant by aspiration without disturbing the cell pellet. Resuspend the cell pellet in 40 mL of D-PBS by gentle up and down pipetting three times. The cells in clumps need to be dispersed (*see Note 3*).
6. Centrifuge the resuspended cell pellet and repeat for a total of two times.
7. Resuspend the final washed cell pellet in an appropriate volume of D-PBS for transfection (approx 1.0×10^7 cells per 0.5 mL; therefore, in the case of six 15-cm dishes, use 2.5–3.0 mL of D-PBS).

3.2. Electroporation of Adipocytes

1. First transfer the supercoiled plasmid DNA (about 100–500 μg) into the bottom of the electroporation cuvet (*see Note 4*).
2. Add 500 μL of the adipocyte cell suspension to the electroporation cuvet and mix the plasmid DNA solution and the suspended cells by gentle tapping (*see Note 5*).
3. Immediately place the cuvet in the Bio-Rad Gene Pulser electroporator and deliver a single pulse with 950 or 960 μF capacitance at 0.16 kV (low-voltage conditions). The time constant is somewhat variable (21–23 ms).
4. After pulse delivery, add 1.0 mL of complete media to the cuvet, gently but quickly. (Use a P-1000 pipet and deliver two aliquots of 500 μL each).
5. Repeat the electroporation step six times (six cuvet for a 6-well collagen-4 coated plate; one cuvet for each well). After completing the last electroporation, remove floating cell debris with a 1.0-mL disposable sterile pipet, then transfer each of the electroporated cell suspension separately to 15-mL conical tubes containing 4 mL of complete media. If the electroporated cell samples in each cuvet contain the same plasmid DNA, then collect all of the cells in the same 50-mL conical tube. Incubate for 10 min at room temperature.
6. Following this 10-min recovery period at room temperature, transfer the cells to the six-well plate. The amount of cells equivalent to one cuvet are placed into each well (one cuvet of cells per well; *see Note 6*).
7. Incubate the six-well plate with the electroporated cells for 12 h in a humidified incubator at 37°C. Replace the medium with fresh complete medium (*see Note 7*). We typically use the adipocytes 30 h after electroporation, but this can be adjusted depending on the experiment conducted (*see Note 8*).

4. Notes

1. We usually use adipocytes 5–8 d postdifferentiation for electroporation (for differentiation of 3T3–L1 adipocytes, see Chapter 10 of this volume).
2. Even when the differentiated 3T3–L1 adipocytes are trypsinized, it is very difficult to remove the adipocytes from the culture dish. Pipetting is the only effective way to remove these cells, but too much pipetting will easily damage the cells. Therefore, do not pipet the cells up and down too forcefully because this reduces the number of viable single adipocyte cells.

3. After centrifuging, the cell pellet has to be dispersed with pipetting in order to wash and isolate the individual fat cells. However, too much pipetting will damage the cells. On the other hand, if the cell clumps are not dispersed completely, this will markedly reduce the efficiency of transfection.
4. If the electroporated adipocytes are used for analysis of GLUT-4 translocation using the sheet assay (as described in Chapter 11 of this volume), use 100–500 μg DNA. In case the adipocytes are utilized for 2-deoxy-glucose uptake assay and immunoprecipitation, use 600 μg of plasmid DNA of interest for each cuvet. For electroporation of enhanced green fluorescent protein (EGFP) constructs, usually 50 μg of EGFP plasmid DNA is sufficient, as this is assayed on a single cell basis.
5. Usually tapping the cuvet 15–20 times is enough. However, you have to work very quickly in order to avoid DNA degradation.
6. If the adipocytes are used in a single-cell-based assay (indirect immunofluorescence microscopy), the electroporated cells can be diluted in an appropriate volume.
7. When replacing the medium, this has to be done with care because at this point the cells are only weakly attached to the plate. Electroporated adipocytes, in general, attach to the tissue culture plate very weakly, therefore, the electroporated cells have to be handled very carefully.
8. The following factors will affect the transfection efficiency:
 - The number of cells in the cuvet.
 - The amount of plasmid DNA.
 - The voltage used for electroporation.

References

1. Olson, A. L., Knight, J. B., and Pessin, J. E. (1997) Syntaxin 4, VAMP2, and/or VAMP3/Cellubrevin are functional target membrane and vesicle SNAP receptors for insulin-stimulated GLUT4 translocation in adipocytes. *Mol. Cell. Biol.* **17**, 2425–2435.
2. Min, J., Okada, S., Kanzaki, M., Elmendorf, J. S., Coker, K. J., Ceresa, B. P., et al. (1999) Synip: a novel insulin-regulated Syntaxin 4-binding protein mediating GLUT4 translocation in adipocytes. *Mol. Cell.* **3**, 751–760.

10

Analysis of Insulin-Stimulated Glucose Uptake in Differentiated 3T3-L1 Adipocytes

Jaganathan Lakshmanan, Jeffrey S. Elmendorf,
and Sabire Özcan

1. Introduction

The long-term complications associated with diabetes such as heart disease, kidney failure, blindness, and limb amputations are mostly the result of chronic elevations in blood glucose levels, also known as chronic hyperglycemia (1,2). The exact molecular mechanisms by which hyperglycemia causes damage to various tissues are unknown. However, it is known that chronic hyperglycemia results in acute metabolic abnormalities such as insulin resistance that leads to worsening of diabetes (2). Insulin resistance results in decreased insulin-stimulated glucose transport into skeletal muscle and adipocyte tissue (3).

Muscle and adipose tissue are insulin-responsive tissues and express the insulin-sensitive glucose transporter GLUT-4 (4). The glucose transporter GLUT-4 translocates from intracellular vesicles to the plasma membrane in response to insulin and causes increased glucose transport into muscle and fat cells (5). Because insulin resistance (decreased GLUT-4 translocation to plasma membrane in response to insulin) is one of the important factors causing NIDDM (non-insulin-dependent diabetes mellitus) (6), it is important to understand how insulin stimulates glucose uptake into insulin-responsive tissues.

3T3-L1 adipocytes are the most preferred cell line to study insulin-stimulated glucose uptake, as most of the available muscle cell lines are not insulin sensitive in terms of glucose transport. 3T3-L1 adipocytes behave like primary adipocytes in many aspects and provide an excellent model system to study

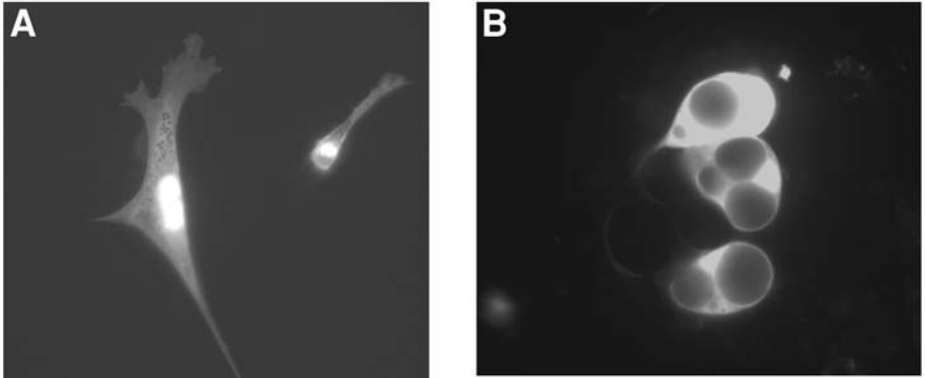

Fig. 1. 3T3-L1 preadipocyte differentiation. The fibroblast like 3T3-L1 preadipocytes (A) differentiate into adipocytes when incubated with insulin, dexamethasone, and 1-isobutyl-1-methylxanthine in the presence of serum. The terminally differentiated adipocytes are spherical in shape and accumulate fat droplets (B). The preadipocytes and differentiated adipocytes were infected with a GFP adenovirus and the photographs were taken using a fluorescence microscope.

insulin action and signaling (7,8). This chapter describes an optimized protocol to differentiate the 3T3-L1 fibroblasts (preadipocytes) into adipocytes and the use of these terminally differentiated adipocytes to measure insulin-stimulated glucose uptake. The preadipocytes are derived from mouse embryonic tissue, exhibit a fibroblast phenotype (see Fig. 1A), and are not insulin sensitive (9). Treating the preadipocytes with a differentiation medium containing insulin, dexamethasone, and 1-isobutyl-1-methylxanthine in the presence of serum induces these cells to become terminally differentiated adipocytes. The preadipocytes then convert to a spherical shape and accumulate fat droplets (see Fig. 1B), and they progressively acquire the morphological and biochemical characteristics of a mature white adipocyte (9). Unlike preadipocytes, which express only the non-insulin-sensitive glucose transporter GLUT-1, fully differentiated 3T3-L1 adipocytes also express the insulin-responsive glucose transporter GLUT-4 (10) and glucose uptake can be activated as much as 15- to 20-fold by insulin (11). The glucose uptake assay using 3T3-L1 adipocytes is usually performed at d 10–12 after initiation of adipocyte differentiation. The adipocytes are first starved of serum, washed, and incubated with insulin to activate GLUT-4 translocation to the plasma membrane. Glucose uptake is measured using radioactive 2-deoxyglucose that cannot be metabolized by the cells. The cells are washed in ice-cold phosphate-buffered saline (PBS) and after lysis used to measure the amount of radioactive 2-deoxyglucose taken up by the cells. The amount of radioactive 2-deoxyglucose taken up by cells incubated without

insulin (basal glucose uptake resulting from the GLUT-1 transporter) is subtracted from the amount of radioactivity taken up by cells incubated with insulin (insulin-stimulated glucose uptake mainly resulting from translocation of GLUT-4) giving the true insulin-stimulated glucose uptake value.

2. Materials

2.1. Differentiation of 3T3-L1 Cells

1. Culture medium A: Dulbecco's modified Eagle's medium (DMEM) with 4.5 g/L glucose, L-glutamine, and sodium pyruvate containing 20% newborn calf serum (Sigma), 2 mM glutamine, 50 U penicillin/mL, and 50 µg streptomycin/mL. Sterile filter through a 0.22-µm filter (*see Note 1*).
2. Culture medium B: DMEM with 4.5 g/L glucose, L-glutamine, and sodium pyruvate containing 10% fetal bovine serum (FBS, HyClone), 2 mM glutamine, 50 U penicillin/mL, and 50 µg streptomycin/mL. Sterile filter through a 0.22-µm filter.
3. Differentiation medium: Culture medium B containing 670 nM insulin, 500 µM dexamethasone (DMX), and 25 nM 1-isobutyl-1-methylxanthine (IBMX); sterile filter.
4. Insulin (Sigma) stock solution: 670 mM (4 mg in 1 mL of 0.01 N HCl); add 100 µL of this stock solution per 100 mL of culture medium B to give a final concentration of 670 nM. Prepare fresh each time.
5. DMX (Sigma) stock solution: 250 µM (1 mg in 10 mL of absolute ethanol); add 10 µL of this stock solution per 100 mL of culture medium B to give a final concentration of 500 µM. Prepare fresh each time.
6. IBMX (Sigma) stock solution: 27.75 mg in 1 mL of solution A (solution A: 1.22 mL of 14.8 N NH₄OH + 18 mL methanol + 16.98 mL water); add 400 µL per 100 mL of culture medium B to give a final concentration of 25 nM. Prepare fresh each time.
7. PBS: Dissolve 8 g NaCl, 0.2 g KCl, 1.44 g Na₂HPO₄, and 0.24 g KH₂PO₄ in 800 mL distilled water. Adjust the pH to 7.4 with HCl. Add water to 1 L.
8. Trypsin-EDTA: 0.05% trypsin, 0.53 mM EDTA-4Na
9. 3T3-L1 Fibroblasts: from ATCC (Cat. no. CL-173).
10. CO₂ incubator.
11. Class II hood.

2.2. Assaying Insulin-Stimulated Glucose Uptake

1. Serum-free media: DMEM (with 4.5 g/L glucose, L-glutamine, and sodium pyruvate) containing 0.5 % bovine serum albumin (BSA).
2. 2-Deoxyglucose (Sigma) stock: 100 mM (16.4 mg/mL in double-distilled water). Store at 2°–4°C up to 2 wk.
3. Cytochalasin B (Sigma) stock: 10 mM (4.796 mg/mL in 95% ethanol). This solution can be stored up to 6 mo at –20°C.
4. Krebs's Ringer phosphate HEPES (KRPH) buffer: 136 mM NaCl, 20 mM HEPES (pH 7.4), 5 mM sodium phosphate buffer (pH 7.4), 4.7 mM KCl, 1 mM MgSO₄, 1 mM CaCl₂; prepare freshly by mixing the following stock solutions: 6.80 mL of 5.0 M NaCl, 5.0 mL of 1.0 M HEPES, 12.50 mL of 0.1 M sodium phosphate buffer,

- pH 7.4 (a mixture of NaH_2PO_4 and Na_2HPO_4), 1.18 mL of 1.0 M KCl, 0.25 mL of 1.0 M MgSO_4 , 0.25 mL of 1.0 M CaCl_2 , adjust the pH to 7.4, and make up the volume to 250 mL with double-distilled water.
5. KRPH–cytochalasin B solution: 20 μM of cytochalasin B in KRPH buffer; add 8 μL of 10 mM cytochalasin B stock solution to 4 mL of KRPH buffer.
 6. Insulin: 670 μM stock (dissolve 1 mg of insulin in 0.25 mL of 0.01 N HCl); dilute 149 μL of insulin stock with 851 μL of water to give a working solution of 100 μM .
 7. KRPH– $[\text{}^3\text{H}]2$ -deoxyglucose label: Mix 25 μL of 100 mM of 2-deoxyglucose stock and 45.5 μL of $[\text{}^3\text{H}]2$ -deoxyglucose (Amersham; 1 mCi/mL; 20 $\mu\text{Ci/mL}$ final concentration) with 2.442 mL of KRPH buffer. Prepare prior to use.
 8. PBS.
 9. NaOH solubilization buffer: 0.2 N NaOH in PBS; prepare fresh.

3. Methods

3.1. Subculturing 3T3-L1 Fibroblasts

1. Grow the 3T3-L1 fibroblasts in culture medium A until 95% confluent on a 10-cm dish at 37°C and 10% CO_2 (see Note 2). All subsequent steps should be carried out under a hood.
2. Wash the confluent cells with 10 mL of sterile PBS twice.
3. Add 0.5 mL trypsin–EDTA solution to the plate; gently swirl the plate to ensure that all the cells are covered with trypsin. Incubate for 5 min at room temperature until the cells are detached (see Note 3).
4. Add 30 mL (usually cells are split in 1 : 3 ratio) of culture medium A and pipet the cells up and down gently to disaggregate the cells, so as to form a uniform suspension of the cells in the media.
5. Plate the cell suspension on three sterile 10-cm plates with 10 mL cell suspension each (to subculture into 35-mm plates; take 60 plates of 35-mm diameter, add 1.5 mL culture medium A, and to each plate add 0.5 mL of the cell suspension). Incubate at 37°C in 10% CO_2 (see Note 4).
6. Replace media every 2 d (see Note 5).
7. Let the cells grow until they reach 95% confluence; usually takes 4 d (see Note 6).

3.2. Differentiation of 3T3-L1 Fibroblasts

1. Replace culture medium A with culture medium B and incubate for 2 d in the incubator.
2. After 2 d, replace culture medium B with freshly prepared differentiation medium (see Note 7) containing freshly prepared solutions of insulin, DMX, and IBMX (see Note 8)—10 mL for a 10-cm plate and 2.0 mL for a 35-mm plate.
3. After 48 h, the differentiation media is replaced with culture medium B containing 670 nM insulin alone (for 100 mL of culture medium B, add 100 μL of 4 mg/mL insulin; sterile filter) (see Note 9).
4. After 2 d and thereafter, add fresh culture medium B every 2 d (see Notes 5 and 9)

- For best results, use the differentiated adipocytes for experiments between d 9 and 15 after initiation of differentiation. Adipocytes, after d 16 of post-differentiation initiation, start to die, lose their phenotype and become increasingly resistant to manipulations such as infection with adenoviruses or electroporation with DNA.

3.3. Assaying Insulin-Stimulated Glucose Uptake

- 3T3-L1 adipocytes differentiated on 35-mm dishes are washed with sterile PBS and incubated in serum-free media for 2 h.
- Wash the cells twice with 2 mL KRPH buffer incubated at 37°C for 15 min (*see Note 10*).
- Divide the cells into two groups and have at least five plates per group. One group is used to determine the basal glucose uptake and the other group is incubated with insulin to measure the insulin-stimulated glucose uptake.
- Add 1 mL of KRPH-cytochalasin B solution to one plate from each group. To the rest of the plates, add 1 mL of KRPH buffer at 1-min interval (*see Note 11*).
- After 5 min, add 10 μL of 100 μM insulin to only one group of plates and incubate for 30 min at room temperature (staggered at 1-min intervals).
- Add 50 μL of KRPH- ^3H 2-deoxyglucose label to all plates and incubate for 10 min.
- After the 10-min incubation, wash the cells with 1 mL ice-cold PBS three times to stop the reaction (glucose uptake, *see Note 12*).
- Air-dry the plates for 15 min at room temperature.
- Add 1 mL ice-cold 0.2 *N* NaOH solubilization buffer, mix cells by pipetting.
- Add 500 μL of the solubilized cells to a scintillation vial containing 5 mL of scintillation cocktail and count the radioactivity. Use 0.5 mL of 0.2 *N* NaOH in 5 mL of scintillation cocktail as the blank, and 2 μL of KRPH- ^3H 2-deoxyglucose label in 0.5 mL 0.2 *N* NaOH with 5 mL of scintillation cocktail to determine the total counts per minute (cpm).
- Use the rest of the lysate (usually 2–5 μL) to determine the protein concentration (we are using the BCA assay with BSA as standard).
- Calculation: From each group of cells (treated with and without insulin), subtract the cpm from cytochalasin B-treated cells (*see Note 13*) from the median cpm of the rest of the cells. This will give the corrected cpm for that group. The glucose uptake values are expressed as “pmol radioactive 2-deoxyglucose taken up per minute and per mg protein”:

$$\begin{aligned} \text{Amount of } [^3\text{H}]2\text{-deoxyglucose taken up (pmol/min/mg protein)} &= \\ &= \left(\frac{\text{Corrected cpm} \times 2 / \text{total cpm} \times 25^a}{10^b \times \text{mg protein per mL}} \right) \end{aligned}$$

a = multiply with 25, because only 2 μL of label was used to measure total cpm while 50 μL of the KRPH- ^3H 2-deoxyglucose label was used for the uptake assay, and $b = 10$ is the time in minutes that the cells were incubated with radioactive 2-deoxyglucose.

4. Notes

1. All media used should be as sterile as possible. As the whole process of differentiation of 3T3-L1 cell involves changing the media a number of times, the risk of contamination is high.
2. Some investigators use DMEM with 10% newborn calf serum instead of 20% for subculturing the preadipocytes.
3. To avoid clumping of the cells, do not agitate the cells by tapping or shaking the culture dish during incubation with trypsin.
4. When subculturing the cells, make sure that the cells are uniformly distributed throughout the plate and not aggregated, because this can affect the differentiation efficiency.
5. Some investigators change the media every 3–4 d.
6. The 3T3-L1 fibroblasts should be at least 95% confluent when differentiation is initiated. Also, do not allow the cells to overgrow because it leads to cell aggregation and clumps. Cells will appear as clumps rather than as a monolayer. Discard plates with clumps of cells and do not attempt to differentiate, as differentiation will not be complete. On the other hand, if the cells are not dense enough, the preadipocytes that have not differentiated tend to divide and cover any vacant space in between the differentiated ones.
7. Maximal differentiation is achieved upon treatment with insulin, DMX, and IBMX (*9,11,12*). About 24 h after initiation of adipogenesis using the differentiation medium, the cells undergo a postconfluent mitosis and subsequent growth arrest (*13*). The cells undergo at least one round of DNA replication and cell division. By 48 h, the cells enter into an unusual growth arrest called G_D (*14*). This mitosis is thought to be essential for DNA to unwind, allowing transcription factors to bind to regulatory elements of genes involved in adipogenesis (*15,16*). The growth arrest is required for subsequent differentiation. At d 3 after initiation of differentiation, late markers of differentiation—the GLUT-4, lipogenic and lipolytic enzymes, and proteins required for modulating mature adipocyte phenotype—begin to express.
8. Although DMX and IBMX stocks can be stored for a month in a -20°C freezer, in our hands fresh solutions give consistently higher percentage of fully differentiated cells.
9. Be gentle while replacing the media. Even a slight force can cause detachment of the cells, especially during the initial stages of differentiation.
10. Always prepare KRPB buffer fresh, because calcium will precipitate as calcium phosphate upon standing.
11. Cytochalasin B is an inhibitor of glucose transport and is extremely toxic. Hence, preparation of all solutions containing cytochalasin B should be done with extreme caution under a hood with suitable protective clothing.
12. The three rinses with ice-cold PBS should be done rapidly, within 1 min, to stop glucose uptake. Alternately, glucose uptake can be stopped by incubating the cells with 3 mL KRPB– $10\ \mu\text{M}$ cytochalasin B solution for 1 min.
13. The cpm with cytochalasin B-treated cells will give the value for non-carrier-mediated glucose uptake.

References

1. Gerich, J. E. (1986) Insulin-dependent diabetes mellitus: pathophysiology. *Mayo Clin. Proc.* **61**, 787–791.
2. Rossetti, L., Giaccari, A., and DeFronzo, R. A. (1990) Glucose toxicity. *Diabetes Care* **13**, 610–630.
3. Mueckler, M. (2001) Insulin resistance and the disruption of Glut4 trafficking in skeletal muscle. *J. Clin. Invest.* **107**, 1211–1213.
4. Pessin, J. E. and Bell, G. I. (1992) Mammalian facilitative glucose transporter family: structure and molecular regulation. *Annu. Rev. Physiol.* **54**, 911–930.
5. Holman, G. D. and Cushman, S. W. (1994) Subcellular localization and trafficking of the GLUT4 glucose transporter isoform in insulin-responsive cells. *BioEssays* **16**, 753–759.
6. Reaven, G. M. (1995) Pathophysiology of insulin resistance in human disease. *Physiol. Rev.* **75**, 473–486.
7. Green, H. and Kehinde, O. (1979) Formation of normally differentiated subcutaneous fat pads by an established preadipose cell line. *J. Cell. Physiol.* **101**, 169–171.
8. Novikoff, A. B., Novikoff, P. M., Rosen, O. M., and Rubin, C. S. (1980) Organelle relationships in cultured 3T3-L1 preadipocytes. *J. Cell. Biol.* **87**, 180–196.
9. Green, H. and Meuth, M. (1974) An established pre-adipose cell line and its differentiation in culture. *Cell* **3**, 127–133.
10. Kaestner, K. H., Christy, R. J., McLenithan, J. C., Braiterman, L. T., Cornelius, P., Pekala, P. H., and Lane, M. D. (1989) Sequence, tissue distribution, and differential expression of mRNA for a putative insulin-responsive glucose transporter in mouse 3T3-L1 adipocytes. *Proc. Natl. Acad. Sci. USA* **86**, 3150–3154.
11. Frost, S. C. and Lane, M. D. (1985) Evidence for the involvement of vicinyl sulfhydryl groups in insulin activated hexose transport by 3T3-L1 adipocytes. *J. Biol. Chem.* **260**, 2646–2652.
12. Student, A. K., Hsu, R. Y., and Lane, M. D. (1980) Induction of fatty acid synthetase synthesis in differentiating 3T3-L1 preadipocytes. *J. Biol. Chem.* **255**, 4745–4750.
13. Smith, P. J., Wise, L. S., Berkowitz, R., Wan C., and Rubin, C. S. (1988) Insulin-like growth factor-I is an essential regulator of the differentiation of 3T3-L1 adipocytes. *J. Biol. Chem.* **263**, 9402–9408.
14. Bernlohr, D. A., Bolanowski, M. A., Kelly, T. J., Jr., and Lane, M. D. (1985) Evidence for an increase in transcription of specific mRNAs during differentiation of 3T3-L1 preadipocytes. *J. Biol. Chem.* **260**, 5563–5567.
15. Scott, R. E., Florine, D. L., Wille, J. J., Jr., and Yun, K. (1982) Coupling of growth arrest and differentiation at a distinct state in the G1 phase of the cell cycle: G_D. *Proc. Natl. Acad. Sci. USA* **79**, 845–849.
16. Cornelius, P., MacDougald, O. A., and Lane, M. D. (1994) Regulation of adipocyte development. *Annu. Rev. Nutr.* **14**, 99–129.

FOR REFERENCE PURPOSES ONLY

Fractionation Analysis of the Subcellular Distribution of GLUT-4 in 3T3-L1 Adipocytes

Jeffrey S. Elmendorf

1. Introduction

In 1980, two groups simultaneously provided evidence of the existence of an intracellular pool of glucose transporters in rat adipocytes (1,2). We now know that facilitative glucose uptake occurs through a family of highly related integral membrane proteins that share significant sequence similarity. Of the established glucose transporter isoforms, GLUT-4 is highly expressed in adipose tissue and striated muscle (3). In the basal state, GLUT-4 cycles slowly between the plasma membrane and one or more intracellular compartments, with the vast majority of the transporter residing in vesicular compartments within the cell interior (4–6). Activation of the insulin receptor triggers a large increase in the rate of GLUT-4 vesicle exocytosis and a smaller decrease in the rate of internalization by endocytosis (7–10). The stimulation of exocytosis by insulin is probably the major step for GLUT-4 translocation because complete inhibition of GLUT-4 endocytosis only modestly increases plasma membrane-associated GLUT-4 protein without affecting the extent of insulin-stimulated GLUT-4 translocation (11–13). In contrast to GLUT-4, GLUT-1 is an intracellular and plasma membrane localized in the basal state and displays a modest insulin-stimulated redistribution to the plasma membrane. Thus, the overall insulin-dependent shift in the cellular dynamics of GLUT-4 vesicle trafficking results in a net increase of GLUT-4 on the cell surface, thereby increasing the rate of glucose uptake.

Abundant studies have used both primary (isolated from adipose tissue by collagenase digestion) and cultured (3T3-L1 adipocyte model system) fat cells

to evaluate insulin action as it pertains to GLUT-4 translocation. This is because these cells can be fractionated into relatively pure membrane fractions. Herein we will focus on the use of the subcellular fractionation technique to analyze GLUT-4 cellular distribution in the 3T3-L1 adipocyte model system. Adipocytes at 10–12 d after withdrawal from differentiation media are routinely used for fractionation, and at this time of adipocyte development, the mRNA and protein levels of GLUT-4 (**14**) together with the glucose-transport response to insulin (**15**) have reached a steady state. Subcellular fractionation of 3T3-L1 adipocytes uses a procedure similar to that developed for the fractionation of isolated adipocytes (**16,17**). Four fractions obtained by differential centrifugation include the plasma membrane (PM), low-density microsomes (LDMs), high-density microsomes (HDMs), and cytosol (CYT). The intracellular pool of GLUT-4 is localized in the LDM. Because of its migration in sucrose density gradients, compared with other subcellular compartments, this membrane fraction is conventionally called the LDM fraction. As well as being enriched with GLUT-4, this fraction contains endosomes and the Golgi apparatus. The HDM fraction is enriched in endoplasmic reticulum but a considerable cross-contamination with PM and LDM organelles is inevitable.

2. Materials

2.1. Cell Culture

1. 3T3-L1 cells (American Type Culture Collection, Manassas, VA, cat. no. CL-173; *see Note 1*).
2. Dulbecco's Modified Eagle's medium (DMEM) (1X), liquid (high glucose; 25 mM). This media contains 4500 mg/L D-glucose, L-glutamine, 110 mg/L sodium pyruvate, and pyridoxine hydrochloride. (Invitrogen Inc., Carlsbad, CA, cat. no. 12378-014). Store at 2–8°C.
3. Penicillin–streptomycin–glutamine (PSG; 100X), liquid. This solution contains 10,000 units of penicillin (base), 10,000 µg of streptomycin (base), and 29.2 mg of L-glutamine/mL in 0.85% saline, in a 10 mM citrate buffer to maintain penicillin potency. Utilizes penicillin G (sodium salt) and streptomycin sulfate (Invitrogen Inc., cat. no. 10378016). Store at –20 to –5°C.
4. Trypsin–EDTA: 0.25% trypsin, 1 mM EDTA·4Na (1X), liquid. This solution contains 2.5 g/L trypsin (1 : 250) and 0.38 g/L EDTA·4Na in Hanks' balanced salt solution (HBSS) without CaCl₂, MgCl₂·6H₂O, and MgSO₄·7H₂O (Invitrogen Inc., cat. no. 25200056). Store at –20 to –5°C.
5. Defined bovine calf serum, iron-supplemented (BCSS; Hyclone Laboratories, Logan, UT, cat. no. SH30072; *see Note 2*). Store at –20 to –5°C.
6. Fetal bovine serum (FBS; Hyclone Laboratories, cat. no. SH30070; *see Note 3*). Store at –20 to –5°C.
7. Dexamethasone (DMX; Sigma, St. Louis, MO, cat. no. D4902). Store at 2–8°C. Stock solution: 1 mg/mL in ETOH. Store at –20 to –5°C for up to 1 mo.

8. Isobutylmethylxanthine (IBMX; Sigma, St. Louis, MO, cat. no. I7018). Store at -20 to -5°C . Make fresh as needed: 55.6 mg/mL in 0.35 M KOH
9. Insulin (Sigma, cat. no. I5500). Store at -20 to -5°C . Stock solution: 1 mg/mL in 0.1 N HCl . Store at 2 – 8°C for up to 1 mo.

2.2. Fractionation

1. Disposable cell scraper (Fisher Scientific, Hanover Park, IL, cat. no. 08-773-2).
2. 10 mL BD Brand syringe (Fisher Scientific, cat. no. 14-823-2A).
3. Needles, BD Brand, 22G1 (Fisher Scientific, cat. no. 14-826B).
4. HEPES–EDTA–sucrose (HES) buffer: 20 mM HEPES , 1 mM EDTA , and 255 mM sucrose , pH 7.4. Store at 2 – 8°C .
5. Aprotinin, stock solution: 10 mg/mL in double-distilled (dd) H_2O . Store at -20 to -5°C for up to 6 mo.
6. Leupeptin, stock solution: 5 mg/mL in ddH_2O . Store at -20 to -5°C for up to 6 mo.
7. Pepstatin, stock solution: 1 mg/mL in MeOH . Store at -20 to -5°C for up to 6 mo.
8. Phenylmethylsulfonyl fluoride (PMSF), stock solution: 100 mM (17.4 mg/mL in isopropanol). Store at -20 to -5°C for up to 6 mo.
9. Sucrose cushion: 38.5% (1.12 M) sucrose, 20 mM HEPES , and 1 mM EDTA , pH 7.4. Store at 2 – 8°C .

3. Methods

3.1. Cell Culture

1. Culture 3T3-L1 cells in 10% calf media (DMEM; high glucose, containing 10% BCSS and 1X PSG; *see Note 4*) at 37°C and 8% CO_2 on 10-cm culture dishes (*see Note 5*)
2. Once plated, change the 10% calf media every 4 d and allow the fibroblasts (preadipocytes) to grow at least 2 d past confluence (approx 8 d postplating).
3. At 2 d past confluence, the cells can be differentiated by removing the 10% calf media and adding differentiation media (DMEM; high glucose, containing 10% FBS, 1X PSG, DMX, $10\text{ }\mu\text{L}/100\text{ mL}$; insulin, $100\text{ }\mu\text{L}/100\text{ mL}$; and IBMX, $200\text{ }\mu\text{L}/100\text{ mL}$).
4. At 4 d after initiation of differentiation (approx 12 d postplating), the differentiation media is removed and an insulin media (DMEM; high glucose, containing 10% FBS, 1X PSG, and insulin, $100\text{ }\mu\text{L}/100\text{ mL}$) is added.
5. At 4 d after initiation of insulin media (approx 16 d postplating), the insulin media is removed and growth media (DMEM; high glucose, containing 10% FBS and 1X PSG) is added. At this point, the cells can be used over the next 4 d (*see Note 6*).

3.2. Fractionation

1. All steps subsequent to the incubation of the cells with or without treatment are performed at 0 – 4°C .

2. Wash cells (four culture dishes [diameter 10 cm]/group) three times with 10 mL of HES buffer.
3. Scrape cells vigorously with a rubber disposable cell scraper in HES buffer (8 mL; 2 mL per dish) containing 1 mM PMSF, 10 $\mu\text{g}/\text{mL}$ pepstatin, 10 $\mu\text{g}/\text{mL}$ aprotinin, and 5 $\mu\text{g}/\text{mL}$ leupeptin and homogenize by passing the cells through a 22-gauge needle 10 times (*see Note 7*).
4. Centrifuge homogenate at 19,000g in a fixed-angle rotor (e.g., JA20 rotor) for 20 min (*see Fig. 1*).
5. Remove the supernatant and centrifuge for 20 min at 41,000g (JA20 rotor). The yielding pellet is designated as the HDM fraction (*see Note 8*).
6. Centrifuge the supernatant for 75 min at 180,000g to pellet the LDM fraction.
7. The supernatant of the 180,000g spin contains the cytosol, and this CYT fraction can be concentrated by centrifugation in Centricon tubes.
8. The pellet from the first centrifugation (19,000g, **step 4**) is resuspended in 5 mL of HES buffer and centrifuged again at 19,000g for 20 min. Resuspend the pellet again in 5 mL of HES buffer, and layer onto a 6.3-mL sucrose cushion (38.5%) and centrifuge for 60 min at 100,000g in a swing-out rotor (e.g., SW41, Beckman).
9. The resulting pellet contains nuclei and mitochondria and is brownish in color. The PM fraction is collected from the top of the sucrose cushion (white fluffy band at sucrose cushion interface), resuspended in 10 mL HES, and repelleted by centrifugation at 40,000g for 20 min.
10. Resuspend all pellets in 0.25–1.0 mL HES to a final protein concentration of 1–5 mg/mL and store at -20°C (*see Notes 9 and 10*).
11. Fractions are then subjected to sodium dodecyl sulfate-polyacrylamide gel electrophoresis (SDS-PAGE) and Western blotting analysis (*see Note 11*).

4. Notes

1. L1 cells are a continuous substrain of 3T3 (Swiss albino) cells developed through clonal isolation. Cells undergo a preadipose-to-adipose-like conversion as they progress from a rapidly dividing to a confluent and contact inhibited state.
2. The purchased BCSS is collected from formula-fed calves, which produce exceptionally high levels of transferrin. It is supplemented with iron to load serum transferrin levels to physiological levels. BCSS is sterile filtered using three sequential 100-nm (0.1- μm) pore-size rated filters. This filtration system virtually eliminates contaminating mycoplasmas from the serum.
3. The purchased FBS is filtered through multiple 40-nm (0.04- μm) pore-size rated filters, which are the most retentive filters used in commercial FBS production. This highly retentive filtration method has been shown to significantly reduce the level of virus particles as small as 60 nm.
4. All media is prepared by filtration (0.2 μm). As recommended by HyClone, we do not heat inactivate the serum products.
5. Cells should be split every 4 d. They can be passaged for approx eight times or until they start to grow at a much faster rate as evidenced by the cell counts. Plating rec-

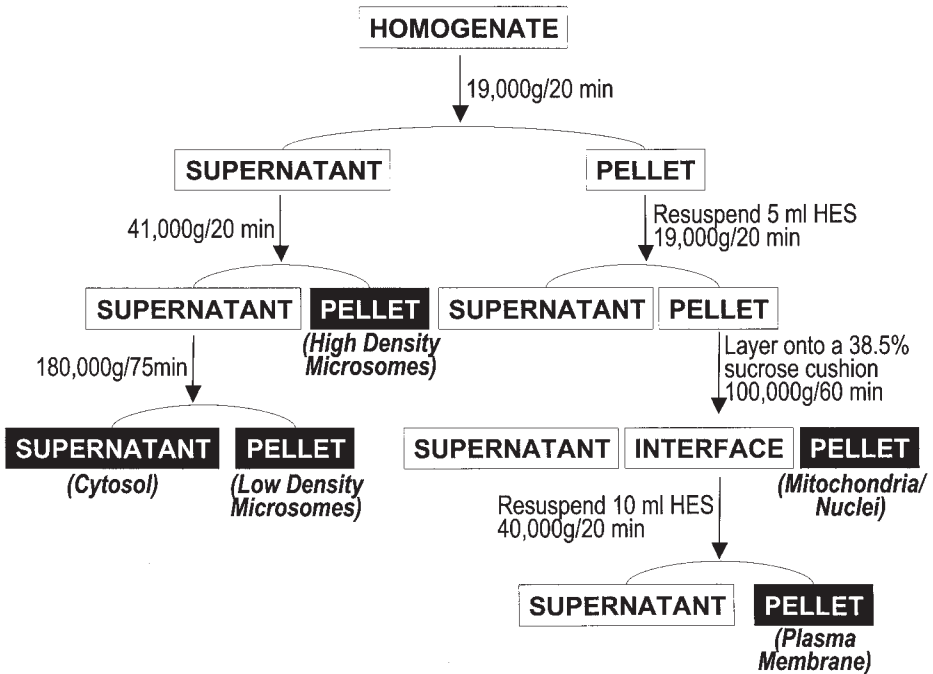

Fig. 1. The subcellular fractionation technique. All steps are performed at 4°C. See text for abbreviations and details.

ommendations: T-150 flask, 100,000 cells; 150-mm dish, 400,000 cells; 100-mm dish, 200,000 cells; 60-mm dish, 100,000 cells; 35-mm dish, 50,000 cells.

6. Adipocytes at 10–12 d after withdrawal from differentiation media are routinely used, because at this time of adipocyte development, the mRNA and protein levels of GLUT-4 (14) together with the glucose-transport response to insulin (15) have reached a steady state.
7. Protease inhibitors should be added to ice-cold HES buffer just prior to use.
8. The pellet containing the HDM fraction is easily dislodged when removing the supernatant. Optimal recovery of the HDM pellet and LDM-containing supernatant can be achieved by carefully pipetting the supernatant out from the opposite side of the pellet while slightly tilting the tube with the pellet facing up. Because the protein yield of the LDM fraction is usually more than sufficient to perform electrophoresis and Western blotting analysis on, it is not necessary to obtain the entire supernatant, thus avoiding the contamination of the LDM fraction with the HDM fraction. The HDM pellet can be washed one or more times by resuspending in HES buffer and repeating the 41,000g/20-min centrifugation step.
9. The approximate total protein (μg) recovered in the HDM, LDM, CYT and PM fractions are 300, 1000, 5000, and 3000, respectively.

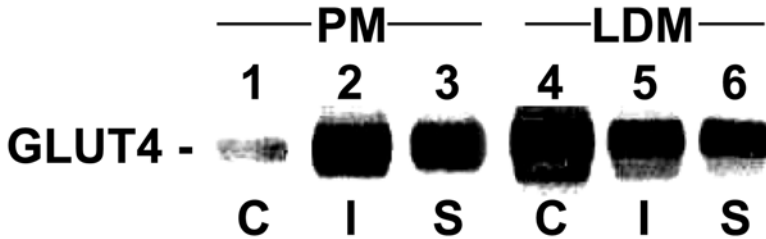

Fig. 2. Effect of insulin and osmotic shock on the subcellular distribution of GLUT-4. Differentiated 3T3-L1 adipocytes were stimulated without (C, lanes 1 and 4) or with 100 nM insulin (I, lanes 2 and 5), or with 600 mM sorbitol (S, lanes 3 and 6) for 30 min, and subcellular membrane fractions were obtained by differential centrifugation. To detect GLUT-4 protein, only 1 μ g of plasma membrane protein (PM, lanes 1–3) and low-density microsomal protein (LDM, lanes 4–6) were separated by SDS-PAGE and transferred to nitrocellulose membranes.

10. The purity of the fractions can be assessed with marker proteins [e.g., Ras (PM marker), GLUT-4 (LDM marker for basal preparations), cytochrome-*c* oxidase (for endoplasmic reticulum), and several others, as described previously (16).
11. Using the “sheet assay,” we previously reported that, similar to insulin, osmotic shock of 3T3-L1 adipocytes stimulates an increase in the level of PM localized GLUT-4 (18). As shown in Fig. 2, stimulation of 3T3-L1 adipocytes with insulin- or sorbitol-induced osmotic shock results in a loss of GLUT-4 protein in the LDM fraction with an increase in the amount of GLUT-4 protein in the PM fraction. The decrease of the transporter in the LDM fraction concomitant with its recruitment to the PM fraction is characteristic of GLUT-4 translocation.

References

1. Cushman, S. W. and Wardzala, L. J. (1980) Potential mechanism of insulin action on glucose transport in the isolated rat adipose cell. Apparent translocation of intracellular transport systems to the plasma membrane. *J. Biol. Chem.* **255**, 4758–4762.
2. Suzuki, K. and Kono, T. (1980) Evidence that insulin causes translocation of glucose transport activity to the plasma membrane from an intracellular storage site. *Proc. Natl. Acad. Sci. USA* **77**, 2542–2545.
3. Charron, M. J., Katz, E. B. and Olson, A. L. (1999) GLUT-4 gene regulation and manipulation. *J. Biol. Chem.* **274**, 3253–3256.
4. Kandror, K. V. and Pilch, P. F. (1996) The insulin-like growth factor II/mannose 6-phosphate receptor utilizes the same membrane compartments as GLUT-4 for insulin-dependent trafficking to and from the rat adipocyte cell surface. *J. Biol. Chem.* **271**, 21,703–21,708.
5. Rea, S. and James, D. E. (1997) Moving GLUT-4: the biogenesis and trafficking of GLUT-4 storage vesicles. *Diabetes* **46**, 1667–1677.

6. Pessin, J. E., Thurmond, D. C., Elmendorf, J. S., Coker, K. J., and Okada, S. (1999) Molecular basis of insulin-stimulated GLUT-4 vesicle trafficking. Location! Location! Location! *J. Biol. Chem.* **274**, 2593–2596.
7. Satoh, S., Nishimura, H., Clark, A. E., Kozka, I. J., Vannucci, S. J., Simpson, I. A., et al. (1993) Use of bismannose photolabel to elucidate insulin-regulated GLUT-4 subcellular trafficking kinetics in rat adipose cells. Evidence that exocytosis is a critical site of hormone action. *J. Biol. Chem.* **268**, 17820–17829.
8. Jhun, B. H., Rampal, A. L., Liu, H., Lachaal, M., and Jung, C. Y. (1992) Effects of insulin on steady state kinetics of GLUT-4 subcellular distribution in rat adipocytes. Evidence of constitutive GLUT-4 recycling. *J. Biol. Chem.* **267**, 17,710–17,715.
9. Yang, J. and Holman, G. D. (1993) Comparison of GLUT-4 and GLUT1 subcellular trafficking in basal and insulin-stimulated 3T3-L1 cells. *J. Biol. Chem.* **268**, 4600–4603.
10. Czech, M. P. and Buxton, J. M. (1993) Insulin action on the internalization of the GLUT-4 glucose transporter in isolated rat adipocytes. *J. Biol. Chem.* **268**, 9187–9190.
11. Shibata, H., Suzuki, Y., Omata, W., Tanaka, S., and Kojima, I. (1995) Dissection of GLUT-4 recycling pathway into exocytosis and endocytosis in rat adipocytes. Evidence that GTP-binding proteins are involved in both processes. *J. Biol. Chem.* **270**, 11,489–11,495.
12. Kao, A. W., Ceresa, B. P., Santeler, S. R., and Pessin, J. E. (1998) Expression of a dominant interfering dynamin mutant in 3T3L1 adipocytes inhibits GLUT-4 endocytosis without affecting insulin signaling. *J. Biol. Chem.* **273**, 25450–25457.
13. Ceresa, B. P., Kao, A. W., Santeler, S. R., and Pessin, J. E. (1998) Inhibition of clathrin-mediated endocytosis selectively attenuates specific insulin receptor signal transduction pathways. *Mol. Cell. Biol.* **18**, 3862–3870.
14. Tordjman, K. M., Leingang, K. A., James, D. E., and Mueckler, M. M. (1989) Differential regulation of two distinct glucose transporter species expressed in 3T3-L1 adipocytes: effect of chronic insulin and tolbutamide treatment. *Proc. Natl. Acad. Sci. USA* **86**, 7761–7765.
15. Resh, M. D. (1982) Development of insulin responsiveness of the glucose transporter and the (Na⁺,K⁺)-adenosine triphosphatase during in vitro adipocyte differentiation. *J. Biol. Chem.* **257**, 6978–6986.
16. Simpson, I. A., Yver, D. R., Hissin, P. J., Wardzala, L. J., Karnieli, E., Salans, L. B., et al. (1983) Insulin-stimulated translocation of glucose transporters in the isolated rat adipose cells: characterization of subcellular fractions. *Biochim. Biophys. Acta* **763**, 393–407.
17. Joost, H. G. and Schurmann, A. (2001) Subcellular fractionation of adipocytes and 3T3-L1 cells. *Methods Mol. Biol.* **155**, 77–82.
18. Chen, D., Elmendorf, J. S., Olson, A. L., Li, X., Earp, H. S., and Pessin, J. E. (1997) Osmotic shock stimulates GLUT-4 translocation in 3T3L1 adipocytes by a novel tyrosine kinase pathway. *J. Biol. Chem.* **272**, 27,401–27,410.

FOR REFERENCE PURPOSES ONLY

12

Visualization and Quantitation of Integral Membrane Proteins Using a Plasma Membrane Sheet Assay

John B. Knight and Ann Louise Olson

1. Introduction

Preparation of plasma membrane (PM) sheets from intact cells is a simple method for obtaining an immobilized cytoplasmic PM surface that can be probed with antibodies or chemical probes. This method was first reported by Robinson et al. (1) who used it to detect the presence of the GLUT-4 glucose transporter at the PM as a result of insulin stimulation. We have extended this technique in order to use it as a means to quickly and efficiently obtain a highly purified plasma membrane fraction (2). We have successfully used this method to detect the GLUT-4 glucose transporter on the cytoplasmic face of the PM as well as using it to quantify total membrane-associated GLUT-4 by western blotting (2,3). The method can be adapted to measure any strongly associated membrane protein possessing an endofacial epitope (e.g., a protein attached to the PM through a membrane-spanning domain). The method relies on sonic disruption of cells that are coated with a positively charged molecule, which allows the exofacial surface of the PM to be drawn into contact with the solid support on which the cells were cultured. Sonication of these cells results in formation of a "lawn" of adherent membrane fragments oriented with their cytoplasmic surfaces facing away from the surface of cell attachment. This uniform orientation allows access to the cytoplasmic surface of the PM using various probes, after fixation by standard microscopy techniques. Typically, the cytoplasmic surfaces are probed using an antibody directed against an endofacial epitope of a membrane-bound protein of interest, and this is, in turn, is detected by a flu-

Basal

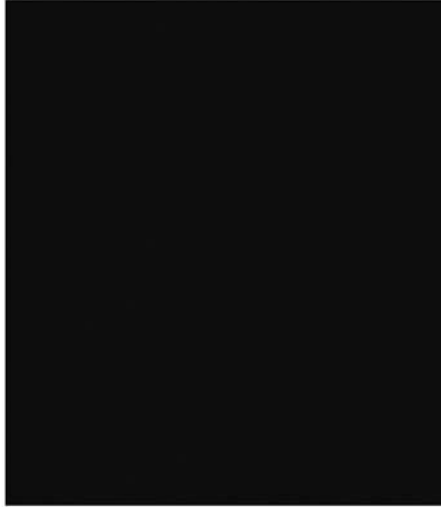

Insulin

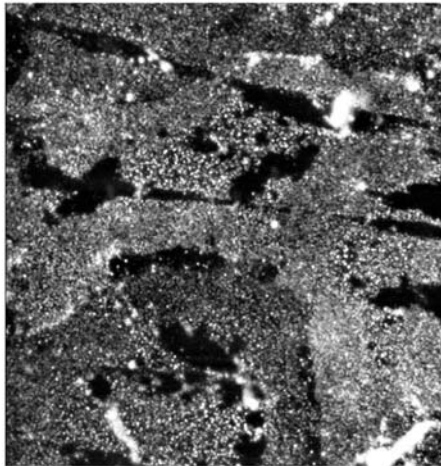

Fig. 1. GLUT-4 immunostaining of plasma membrane sheets

orescent secondary antibody (*see Fig. 1*). Alternatively, the entire PM fraction can be solubilized and assayed for the total quantity of the protein of interest. Cells to be viewed by microscopy can be grown on coated cover slips, tissue culture microscope chamber slides, or directly on tissue culture dishes (35 mm or larger) if an inverted microscope is to be used for viewing, or on cover slips if an inverted microscope is not used. Cells to be used for PM fractionation are

grown on tissue culture dishes of a size sufficient to produce a detectable amount of the protein of interest. For detection of GLUT-4, 35-mm dishes are sufficient to achieve a strong signal by Western blotting.

2. Materials

2.1. Preparation of Plasma Membrane Sheets

1. Phosphate-buffered saline (PBS): 137 mM NaCl, 2.7 mM KCl, 4.3 mM Na₂HPO₄ · 1.4 mM KH₂PO₄, pH 7.3.
2. Poly-D lysine: 0.5 mg/ml poly-D-lysine (Sigma) dissolved in PBS. Make a 5 mg/mL solution, aliquot 0.5 mL in a tube of at least 10 mL volume (to accommodate later dilution) and store aliquots at -20°C.
3. KHMgE buffer: 70 mM KCl, 30 mM HEPES, 5 mM MgCl₂, 3 mM EGTA, pH 7.5.
4. Swelling buffer: KHMgE diluted 1 : 3 (1/3X concentration).
5. Sonication buffer: 1X KHMgE buffer containing 1 mM dithiothreitol (DTT) and 1 mM polymethylsulfonyl fluoride (PMSF). Add DTT and PMSF immediately before use.

2.2. Immunofluorescence

1. Paraformaldehyde fix (2% paraformaldehyde in 1X KHMgE): Dissolve paraformaldehyde in 10 mL (1/2 volume) heated H₂O plus one drop 5 M KOH, then add 10 mL (1/2 volume) of 2X KHMgE and check pH (should be around 7). Stable at room temperature for approx 1 wk. Do not store below 20°C. Alternatively, stock paraformaldehyde at a concentration of 16% may be obtained from Electron Microscopy Services (Ft. Washington, PA) and diluted to 2% in a final solution of 1X KHMgE. This reagent is packed under nitrogen gas and is stable at room temperature indefinitely. Do not store below 20°C.
2. Quench: 2.5 mg/mL NaBH₄ in 50% ethanol. Make immediately prior to use.
3. Blocking solution: 5–10% serum diluted in PBS. The blocking serum should correspond to the fluorochrome-labeled secondary antibody (species-specific).
4. Mounting medium: SloFade or ProLong (Molecular Probes, Eugene, OR).

2.3. Western Blotting

1. Tris-buffered saline (TBS): 137 mM NaCl, 5 mM KCl, 1.4 mM Na₂HPO₄, 25 mM Tris-HCl (pH 7.5).
2. Solubilization buffer: 1% sodium dodecyl sulfate (SDS), 20 mM HEPES (pH 7.5), 150 mM NaCl, 1 mM EDTA.
3. 0.2 M Sodium borate, pH 9.0.
4. Fluorescamine solution: 0.2 mg fluorescamine dissolved in 1 mL acetonitrile.
5. Transfer buffer: 25 mM Tris, 193 mM glycine, pH 8.5.
6. TBS–0.1% Tween-20.
7. Blocking buffer: 7% milk in TBS–0.3% Tween-20

8. Secondary antibody dilution buffer: 10 mL blocking buffer plus 20 mL TBS–0.1% Tween-20

3. Methods

3.1. Preparation of Plasma Membrane Sheets

Preparation of a PM lawn from adherent tissue culture cells is performed essentially according to the method of Robinson et al. (1). Following sonication, PM sheets can be fixed for viewing by indirect immunofluorescence or solubilized for Western blot analysis. Either method of analysis may be carried out on 35-mm six-well tissue culture dishes, provided an inverted microscope is to be used for fluorescence analysis. If it is not, cells must be grown on cover slips. Volumes given in the following protocol are adapted to 35-mm dishes.

1. Wash cells once in ice-cold PBS.
2. Cover well (or cover slip) with 2 mL cold poly-D-lysine (0.5 mg/mL) and incubate for 30 s.
3. Rinse three times with 5 mL swelling buffer (1/3X KHMgE). Allow 5 s per rinse (see Note 1).
4. Fill dish to brim with sonication solution (approx 15 mL) and sonicate at level 6 for 5 s. (Fisher sonic dismembrator model 550) using a 5-mm microtip, approx 1 cm from the surface of the plate (see Note 1).
5. Remove undisrupted cells by swabbing the outer rim of the tissue culture well with a cotton-tipped applicator (see Note 2).
6. Rinse three times with sonication solution (5 mL for each rinse) to remove cell debris. At this point, the plasma membrane sheets may be fixed for indirect immunofluorescence or solubilized for Western blot analysis.

3.2. Immunofluorescence

1. Cover with 3 mL paraformaldehyde fix and incubate for 20 min at room temperature (RT).
2. Wash three times (5 min each) with PBS.
3. Cover with quench and incubate for 10 min at RT (see Note 3).
4. Repeat step 3 two more times (total of three quenches).
5. Wash three times (5 min each) with PBS.
6. Block in 5% serum (in PBS) for 10 min at RT or overnight at 4°C (see Note 4).
7. Incubate with primary antibody for 1 h at RT (see Note 5).
8. Wash three times (10 min each) with PBS.
9. Incubate with secondary antibody 30 min to 2 h at RT in the dark.
10. Wash three times (10 min each) with PBS.
11. Rinse briefly with water.
12. Cover cells with a drop of mounting medium and place a cover slip on top (see Note 6) or mount cover slips on slides if cells were cultured in this manner.

3.3. Western Blotting

Dissolve PM sheets in 100 μL solubilization buffer and transfer entire sample to a microcentrifuge tube using a cell scraper. Determine the total protein content of the sample by performing spectrofluorometric analysis as follows.

1.
 - a. Dilute 10 μL of the solubilized PM fraction in 60 μL in solubilization buffer.
 - b. Mix with 0.25 mL of 0.2 M sodium borate buffer (pH 9.0), and incubate at RT for 5 min.
 - c. Add 20 μL of fluorescamine solution while vortexing vigorously.
 - d. Following a 20-min incubation at RT, measure fluorescence at 395 nm excitation and 460 nm emission using a Shimadzu RF5000U spectrofluorophotometer set at high sensitivity. A standard curve should be performed using bovine serum albumin (BSA) in the range from 0.1 to 15 $\mu\text{g}/\text{mL}$.
2. Fractionate samples using SDS-PAGE.
3. Transfer to polyvinylidene difluoride (PVDF) membranes (Millipore) in transfer buffer for 3–4 amp hours at 4°C.
4. Following transfer, incubate membrane in TBS–0.1% Tween-20 for at least 10 min.
5. Incubate in blocking buffer twice for 30 min each at RT.
6. Rinse three times quickly with TBS–0.1% Tween-20.
7. Incubate with primary antibody solution for 1 h at RT with constant slow agitation. The primary antibody is diluted as recommended by the manufacturer in 2% BSA in TBS–0.1% Tween-20 with 0.02% Sodium azide. After incubation, return antibody to tube for reuse.
8. Perform the following washes at room temperature:
Wash three times quickly with TBS–0.1% Tween-20. Wash three times for 15 min per wash with TBS–0.1% Tween-20.
9. Dilute horseradish peroxidase-conjugated secondary antibodies (Pierce) 1:5,000 in secondary antibody dilution buffer and incubate PVDF membrane for 1 h at RT with constant slow agitation.
10. Perform the following washes at room temperature:
Three times quickly with TBS–0.1% Tween-20;
Three times for 15 min each with TBS–0.1% Tween-20;
Three times quickly with TBS;
Wash once for 5 min with TBS.
11. Carry out ECL reaction for detection of proteins of interest using the enhanced chemiluminescence system (Pierce) according to manufacturer's specifications and quantify by scanning laser densitometry.

4. Notes

1. The power levels given are provided as a starting point and should be determined empirically for each apparatus. It is important to note that success of this technique is more dependent on achieving turgid cells during the swelling procedure than it is on the amount of sonic force; therefore, a range of power levels is acceptable. It

must also be noted that cells should be disrupted with the minimum adequate power level in order to preserve as many of the attached cytoplasmic membrane components as possible. The swath of disruption caused by sonication is visible with the naked eye and is approx 75–100 mm wide. Complete systematic coverage of a 35-mm tissue culture dish should take approximately 6–10 s.

2. Cells positioned near the side of the tissue culture dish may be protected from disruption by the probe, resulting in a ring of intact cells. Removal of these cells is particularly important in the Western blotting of GLUT-4 because deposits of GLUT-4 sequestered in the interior of the cells may confound results. Removal of these cells is less critical in immunofluorescence.
3. Sodium borohydrate quenches free aldehyde groups that may cause background autofluorescence near 488 nm. This step may be omitted if this wavelength is not used; it is most often used after fixation steps that include glutaraldehyde. This step is included in this procedure because it may improve the signal-to-noise ratio.
4. The blocking serum should correspond to the labeled secondary antibody.
5. When using tissue culture dishes, it may be desirable to conserve antibody by limiting the area of coverage. This area can be limited such that fewer than 100 μL of diluted antibody is required by forming a boundary by swabbing with a dry cotton-tipped applicator and following this with an application of an inert hydrophobic film such as vacuum grease or wax (do not use vaseline). If cells have been cultured on cover slips, incubation may be performed by inverting the cover slips onto a drop of diluted antibody placed on parafilm.
6. This method produces fixed samples on a six-well tissue culture dish. These must be viewed through the cover slips and not the plastic dish, necessitating use of an inverted microscope. In addition, it may be necessary to unscrew one or more of the microscope objectives in order to access the surface of the cover slip with the desired objective.

References

1. Robinson, L. J., Pang, S., Harris, D. S., Heuser J., and James, D. E. (1992) Translocation of the glucose transporter (GLUT-4) to the cell surface in permeabilized 3T3-L1 adipocytes: effects of ATP and GTP γ S and localization of GLUT-4 to clathrin lattices. *J. Cell Biol.* **117**, 1181–1196.
2. Knight, J. B., Cao, K. T., Gibson G. V., and Olson, A. L. (2000) Expression of a prenylation-deficient Rab4 interferes with propagation of insulin signaling through insulin receptor substrate-1. *Endocrinology* **141**, 208–218.
3. Olson, A. L., Knight, J. B., and Pessin, J. E. (1997) Syntaxin 4, VAMP2, and/or VAMP3/Cellubrevin are functional target membrane and vesicle SNAP receptors for insulin-stimulated GLUT-4 translocation in adipocytes. *Mol. Cell. Biol.* **17**, 2425–2435.

13

Assaying Tyrosine Phosphorylation of Insulin Receptor and Insulin Receptor Substrates

Eileen L. Whiteman and Morris J. Birnbaum

1. Introduction

This chapter describes techniques to successfully detect tyrosine phosphorylation of the insulin receptor and insulin receptor substrate proteins. These assays demonstrate whether the insulin signaling pathway is activated at its earliest stages.

The insulin receptor (IR) is a transmembrane glycoprotein whose subunits are joined by disulfide bonds to create an $\alpha_2\beta_2$ heterotetramer. Its extracellular α -subunits constitute the binding domain for insulin. The transmembrane and intracellular β -subunits provide the receptor tyrosine kinase activity, and each β -subunit contains 13 tyrosine residues. Among these, six or seven are phosphorylated in response to insulin binding (reviewed in **ref. 1**). Although three of these (Y1146, Y1150, Y1151) are essential residues in the regulatory region that confer kinase activity to the receptor, the membrane proximal Y960 is important for interactions with IRS-1 and IRS-2 (reviewed in **ref. 2**). Thus, the β -subunit can be detected as a tyrosine phosphorylated protein migrating at approx 95 kDa by reducing sodium dodecyl sulfate–polyacrylamide gel electrophoresis (SDS-PAGE).

In contrast to many receptor tyrosine kinases, the insulin receptor does not activate downstream enzymes solely via recruitment to phosphorylated tyrosines on the receptor itself (reviewed in **ref. 3**). Rather, the insulin receptor phosphorylates a family of scaffolding proteins, the insulin receptor substrates (IRS), on a number of tyrosine residues. In IRS-1, for example, among the more than 20 potential tyrosine phosphorylation sites, eight have been confirmed by amino acid sequencing to be phosphorylated in response to insulin treatment (**4**). The

IRS proteins are then competent to assemble signaling complexes via association with SH₂-domain-containing enzymes (e.g., PI3'-kinase, SHP-2, Fyn) and adapter proteins (e.g., Grb2, Nck, Crk) (reviewed in **ref. 5**). Each of the four IRS isoforms contains a pleckstrin homology (PH) and protein tyrosine binding (PTB) domain, and these structural elements assist IRS in localizing at the plasma membrane and in associating with the insulin receptor for productive phosphorylation. The IRS isoforms exhibit differential expression patterns and functions. In addition, these adapters are not used exclusively by the insulin receptor. For instance, IRS-1 is involved in transducing the signals emanating from the IGF-1 receptor as well as from receptors in the interleukin and interferon families.

The simplest method for detection of IR or IRS tyrosine phosphorylation involves resolving the total cell lysates (or tissue lysates) by SDS-PAGE and then immunoblotting with phosphotyrosine antibodies. In this manner, the proteins are identified only by their approximate molecular weights and the presence of phosphotyrosine in response to insulin (e.g., IR- β at 95 kDa, IRS-1 and IRS-2 at 160–185 kDa, IRS-3 at 60 kDa, and IRS-4 at 120 kDa). However, a more reliable way to analyze tyrosine phosphorylation of IR- β or specific IRS isoforms employs an immunoprecipitation step to isolate the protein followed by size separation on an acrylamide gel. In the immunoprecipitation step, a specific antibody is used to capture the protein of interest, and the immune complex is then pelleted by the addition of immunoadsorbant. All of the other molecules present in the cell lysate are removed by thoroughly washing the beads, resulting in a purification of up to 10,000-fold. The protein is then fractionated an additional 10- to 100-fold by size separation on the protein gel. A complete review of immunoprecipitation techniques and theories is provided in **ref. 6**. The widespread commercial availability of excellent immunoreagents for the insulin receptor and IRS proteins makes this approach very feasible. Some of the methods and reagents used with success in our laboratory are described here.

2. Materials

2.1. Cell Culture and Harvest

1. Bovine serum albumin (BSA) tested for the absence of contaminating growth factors.
2. Dulbecco's modified Eagle's medium (DMEM) supplemented with 0.5% BSA. Store at 4°C in the dark.
3. Leibovitz's L-15 medium (L-15) supplemented with 0.2% BSA. Store at 4°C in the dark.
4. Insulin stock solution prepared at approx 2 mg/mL (approx 300 μ M) in 0.005 *N* HCl. Store at 4°C and dilute with physiological buffer (e.g., [phosphate-buffered saline] PBS) as needed.

5. High-salt, nondenaturing lysis buffer: 20 mM Tris-HCl (pH 7.5), 150 mM NaCl, 10% glycerol, 1% Triton X-100, 200 mM NaF, 5 mM EDTA, 1 mM EGTA. Store at 4°C. Add general protease inhibitor cocktail and tyrosine phosphatase inhibitor sodium orthovanadate (1 mM Na₃VO₄) fresh. Both are available from Sigma (*see Note 1*).
6. Phosphate-buffered saline (PBS): 137 mM NaCl, 2.7 mM KCl, 4.3 mM Na₂HPO₄, 1.4 mM KH₂PO₄. Check that the solution is pH 7.4. Store at 4°C. Add 0.88 mM CaCl₂ and 0.49 mM MgCl₂ when washing cells.
7. Bicinchoninic Acid Protein Assay Kit (available from Pierce) or any other suitable method to determine protein concentration.
8. Humidified tissue culture incubator set at 37°C, 7.5% CO₂.
9. Air incubator set at 37°C.
10. Refrigerated microfuge.
11. Spectrophotometer or plate reader.

2.2. Immunoprecipitation

1. Protein-A agarose or protein-G agarose (consult **ref. 6** for the appropriate immunoabsorbant to use with antibodies according to their isotypes and species of origin). Wash three times in lysis buffer just before use and resuspend as a 1:1 slurry of agarose beads buffer. Store at 4°C.
2. Antibodies which immunoprecipitate IR and IRS. Some good choices are: rabbit anti-insulin receptor-β (C-19) from Santa Cruz Biotechnology (sc-711), rabbit anti-IRS-1 from Upstate Biotechnology (06-248), and rabbit anti-IRS-2 from Upstate Biotechnology (06-506).
3. Rotator/nutator.
4. Vortex

2.3. Protein Gel Electrophoresis

1. Solutions and methods to prepare standard SDS-PAGE (7.5% acrylamide) and Laemmli sample loading buffer are detailed in **ref. 7**.
2. Hamilton syringe (50-μL capacity)
3. Standard SDS-PAGE equipment with power supply.
4. Room temperature microfuge.

2.4. Immunoblotting

1. Solutions and methods for standard tank transfer of proteins to nitrocellulose are described in **ref. 8**.
2. Nitrocellulose.
3. Ponceau S (available from Sigma). Prepare and use according to manufacturer's instructions.
4. Tris-buffered saline with Tween-20 (TBST): 50 mM Tris-HCl (pH 7.5), 150 mM NaCl, 0.2% Tween-20.

5. Nonfat dry milk. Prepare a solution of 5% milk in TBST. Make fresh and store at 4°C for short term use.
6. Antibodies that detect phosphotyrosine residues. Some good choices are mouse anti-ptyr (PY20) from Zymed Laboratories (03-7799), mouse anti-ptyr (4G10) from Upstate Biotechnology (05-321), and HRP-PY99 from Santa Cruz Biotechnology (sc-7020 HRP). It is important to note that each of these monoclonal antibodies displays slightly different specificity for phosphotyrosine residues, and they recognize phosphotyrosine residues in the context of the flanking peptide sequence. Thus, it is worth trying more than one monoclonal in order to optimize phosphotyrosine detection.
7. HRP-Conjugated secondary antibodies. HRP-goat-anti-rabbit (sc-2004) and HRP-goat-anti-mouse (sc-2005) secondary antibodies can be obtained from Santa Cruz.
8. Enhanced chemiluminescence detection kit (ECL, available from Amersham Pharmacia).
9. X-ray film.
10. Standard gel-transfer equipment.
11. Shaker.
12. X-ray cassettes.
13. Film developer/processor.

3. Methods

The methods described in this section were developed for 3T3-L1 adipocytes, a murine-derived tissue culture model system for adipose tissue (*see* Chapter 9). However, the protocols should be easily adapted for use with other cell lines or tissues expressing insulin receptor and insulin receptor substrates. However, it should be noted that IR and IRS proteins are expressed in many cell types at levels considerably lower than in 3T3-L1 adipocytes. The volumes and quantities detailed here are appropriate for adipocytes cultured in 6-well dishes (approx 150,000 cells/well; *see* **Note 2**).

3.1. Cell Culture and Harvest

1. Grow and maintain cells as appropriate in complete medium. Serum-starve the cells overnight (12–16 h) in DMEM supplemented with 0.5% BSA in the 37°C tissue culture incubator prior to analysis.
2. The next morning, exchange the medium for L-15 supplemented with 0.2% BSA for 2 h and transfer the cells to the 37°C air incubator.
3. Incubate the cells with 100 nM insulin (+) or buffer alone (–) for 2 min.
4. Wash the cells twice with 2 mL ice-cold PBS.
5. Add 200 μ L ice-cold lysis buffer per well and harvest with a cell monolayer scraper. Transfer the lysate to Eppendorf tubes.
6. Incubate the lysates on ice for 30 min.
7. Pellet the nuclei and insoluble cell debris by microfuging the tubes at 10,000g for 15 min at 4°C.

8. Transfer the supernatant to fresh tubes and determine the protein concentration.

3.2. Immunoprecipitations

1. Prepare samples to immunoprecipitate at a final concentration of 1 mg/mL protein in equivalent volumes (supplement with lysis buffer as required). For immunoprecipitation of IR- β , samples containing 200 μ g protein work well. For IRS-1 or IRS-2, 500 μ g protein or 1 mg protein per immunoprecipitation, respectively, is required for detection.
2. Add appropriate antibody. Generally, 0.5 μ g anti-IR- β , 4 μ g anti-IRS-1, or 10 μ g anti-IRS-2 antibodies from the sources described in **Subheading 2.2.** work well to immunoprecipitate these proteins effectively. Rotate the tubes 1–2 h at 4°C (*see Note 3*).
3. Capture the immune complexes with the addition of 30 μ L protein-A-agarose. Rotate for at least 30 min at 4°C.
4. Pellet the agarose beads with a brief 10-s spin in the refrigerated microfuge. Remove and save a small aliquot of the supernatant. Then, aspirate the remaining supernatant and wash the protein-A-agarose beads with 0.5–1 mL lysis buffer. Repeat two more times. When removing the buffer from the final wash, use a 1-cm³ syringe needle (26G5/8) attached to the aspirator to remove *all* of the wash solution from the beads.
5. Elute the immune complexes from the beads with the addition of 30 μ L Laemmli sample buffer. Vortex well and boil the samples in Laemmli buffer 3–5 min. Pellet the agarose beads by centrifuging in a microcentrifuge for 1 min at maximum speed, at room temperature.

3.3. Protein Gel Electrophoresis

1. In addition to the immunoprecipitated protein samples described in **Subheading 3.2.**, prepare a total cell lysate sample (approx 20 μ g) and an equivalent quantity of postimmunoprecipitation supernatant to run on every gel. This will allow determination of immunoprecipitation efficiency.
2. Using the Hamilton syringe, load half of each immunoprecipitation sample on duplicate gels. (Rinse the syringe with SDS-PAGE running buffer between samples.) Later, the membranes will be immunoblotted for the protein of interest (e.g., IR or IRS) to determine equivalent immunoprecipitation efficiency among samples and for phosphotyrosine signal from the immunoprecipitated protein (*see Note 4*).
3. Resolve the samples on a 7.5% acrylamide mini-gel (*see Note 5*).

3.4. Immunoblotting

1. Transfer the proteins from the acrylamide gel to nitrocellulose using standard tank-transfer methods.
2. Following transfer, rinse the nitrocellulose with distilled water and stain the membrane with Ponceau S to check for uniform transfer of proteins across the blot. Remove the Ponceau S by rinsing with PBS.

3. Block the membranes in a solution of 5% milk-TBST for at least 1 h at room temperature (*see Note 6*).
4. Incubate the membrane in primary antibody in a solution of 3% milk-TBST for at least 1 h at room temperature. The following concentrations of primary antibody have been shown to work well for these assays in our laboratory: anti-ptyr (PY20) at 1 $\mu\text{g/mL}$, anti-ptyr (4G10) at 1 $\mu\text{g/mL}$, HRP-anti-ptyr (HRP-PY99) at 0.2 $\mu\text{g/mL}$, anti-IR- β at 1 $\mu\text{g/mL}$, anti-IRS-1 at 0.5 $\mu\text{g/mL}$, and anti-IRS-2 at 0.25 $\mu\text{g/mL}$ (*see Note 7*).
5. Wash the blots three times (10 min/wash) in generous amounts of TBST.
6. Incubate the membranes in secondary antibody in a solution of 3% milk-TBST for 45 min to 2 h at room temperature. The following concentrations of secondary antibody have been shown to work well in our laboratory: HRP-anti-rabbit at 0.1 $\mu\text{g/mL}$ and HRP-anti-mouse at 0.2 $\mu\text{g/mL}$ (*see Note 8*).
7. Wash the blots three times (10 min/wash) in generous amounts of TBST.
8. Rinse the blots once with PBS.
9. Develop using an enhanced chemiluminescence (ECL) detection kit according to the manufacturer's instructions and expose to film.

4. Notes

1. This high-ionic-strength buffer, described in **ref. 9**, is important for efficient extraction and solubilization of the IRS proteins. In our laboratory, Triton X-100 yields improved solubilization in comparison to NP-40-based lysis buffers. In addition, the high-salt content of the buffer is essential to successful extraction of IRS proteins from 3T3-L1 adipocytes. In this cell type, IRS is reported to maintain tight association with the cytoskeleton, and the high-salt concentration likely aids in the dissociation of IRS proteins from cytoskeletal elements (**10**).
2. Because 3T3-L1 adipocytes do not express IRS-3 nor IRS-4, only methods to assay IRS-1 and IRS-2 tyrosine phosphorylation are detailed here (**11,12**). Antibodies that selectively recognize IRS-3 and IRS-4 are available from Upstate Biotechnology.
3. Titrate the antibodies empirically for each cell line/tissue, quantity of protein, and antibody of choice to determine ideal immunoprecipitation conditions. These assays also work if the immunoprecipitating antibody recognizes phosphotyrosine; however, this precludes the opportunity to probe for equivalent immunoprecipitation of total IR or IRS protein among all the samples. Immunoprecipitations can be performed overnight at 4°C; however, some loss of phosphorylation may result.
4. If lysate is limiting or the protein of interest is expressed at very low levels, the entire immunoprecipitated sample can be loaded on one gel. The blot should be probed first for phosphotyrosine signal, as the phosphates are often labile. The blot can be stripped effectively using a reagent such as Restore™ from Pierce. It can then be reblocked and reprobed with antibodies to detect total IR or IRS.
5. The simplest way to detect IR or IRS tyrosine phosphorylation is to run 20–30 μg total cell lysate samples on a protein gel and probe the blot using phosphotyrosine antibodies.
6. The blots can be incubated in blocking solution overnight at 4°C.

7. The HRP-PY99 antibody, which does not require a secondary antibody, yields very clean phosphotyrosine blots. However, it is also a less sensitive mode of detection because it does not employ the typical amplification step that is intrinsic to the addition of HRP-conjugated secondary antibodies. If the phosphotyrosine signal is weak, it is better to use a simple anti-phosphotyrosine primary antibody (e.g., PY20, 4G10, PY99) and then perform the standard secondary antibody incubation with an HRP-anti-mouse-IgG antibody. In addition, choosing the most sensitive type of film available will also help in successful signal detection (e.g., X-OMAT AR from Kodak). The blots can be incubated in primary antibody overnight at 4°C; however, the blots should be developed as quickly as possible to prevent loss of the phosphorylated tyrosines.
8. Incubating the blots in secondary HRP-conjugated antibodies for longer than 2 h increases background intensity.

Acknowledgment

ELW is supported by a Howard Hughes Pre-Doctoral Fellowship for the Biological Sciences.

References

1. Flier, J. S. (1996) The insulin receptor, in *Diabetes Mellitus: A Fundamental and Clinical Text* (LeRoith, D., Taylor, S. I., and Olefsky, J. M., eds.), Lippincott-Raven, Philadelphia, pp. 148–154.
2. White, M. F. (1996) The role of IRS-1 during insulin signaling, in *Diabetes Mellitus: A Fundamental and Clinical Text* (LeRoith, D., Taylor, S. I., and Olefsky, J. M., eds.), Lippincott-Raven, Philadelphia, pp. 154–160.
3. Schlessinger, J. (2000) Cell signaling by receptor tyrosine kinases. *Cell* **103**, 211–225.
4. Sun, X., Crimmins, D., Myers, M., Jr., Miralpeix, M., and White, M. (1993) Pleiotropic insulin signals are engaged by multisite phosphorylation of IRS-1. *Mol. Cell. Biol.* **13**, 7418–7428.
5. White, M. F. (1997) The insulin signalling system and the IRS proteins. *Diabetologia* **40** (Suppl. 2), S2–S17.
6. Harlow, E. and Lane, D. (1999) *Using Antibodies: A Laboratory Manual*, Cold Spring Harbor Laboratory Press, Cold Spring Harbor, NY.
7. Gallagher, S. R. (1999) One-dimensional SDS gel electrophoresis of proteins, in *Current Protocols in Molecular Biology* (Ausubel, F. M., Brent, R., Kingston, R. E., Moore, D. D., Seidman, J. G., Smith, J. A., et al., eds.), Wiley, New York, Vol. 2, pp. 10.12A.11–10.12A.34.
8. Gallagher, S. R., Winston, S. E., Fuller, S. A., and Hurrell, J. G. R. (1997). Immunoblotting and immunodetection, in *Current Protocols in Molecular Biology* (Ausubel, F. M., Brent, R., Kingston, R. E., Moore, D. D., Seidman, J. G., Smith, J. A., et al., eds.), Wiley, New York, Vol. 2, pp. 10.18.11–10.18.21.

9. Staubs, P. A., Nelson, J. G., Reichart, D. R., and Olefsky, J. M. (1998). Platelet-derived growth factor inhibits insulin stimulation of insulin receptor substrate-1-associated phosphatidylinositol 3-kinase in 3T3-L1 adipocytes without affecting glucose transport. *J. Biol. Chem.* **273**, 25139–25147.
10. Clark, S. F., Martin, S., Carozzi, A. J., Hill, M. M. & James, D. E. (1998) Intracellular localization of phosphatidylinositide 3-kinase and insulin receptor substrate-1 in adipocytes: potential involvement of a membrane skeleton. *J. Cell Biol.* **140**, 1211–1225.
11. Lavan, B. E. and Lienhard, G. E. (1993) The insulin-elicited 60-kDa phosphotyrosine protein in rat adipocytes is associated with phosphatidylinositol 3-kinase. *J. Biol. Chem.* **268**, 5921–5928.
12. Fantin, V. R., Lavan, B. E., Wang, Q., Jenkins, N. A., Gilbert, D. J., Copeland, N. G., et al. (1999) Cloning, tissue expression, and chromosomal location of the mouse insulin receptor substrate 4 gene. *Endocrinology* **140**, 1329–1337.

Measuring Insulin-Stimulated Phosphatidyl-Inositol 3-Kinase Activity

Li-Ping Wang and Scott A. Summers

1. Introduction

Numerous growth factors, hormones, and transforming oncogenes activate phosphatidylinositol 3-kinase (PI3K), an enzyme that phosphorylates the 3'-hydroxyl position of phosphoinositides to generate the intracellular messengers phosphatidylinositol-3-phosphate [PI(3)P], phosphatidylinositol-3,4-bisphosphate [PI(3,4)P₂], and phosphatidylinositol-3,4,5-trisphosphate [PI(3,4,5)P₃] (reviewed in **ref. 1**). PI3K commonly participates in signaling pathways leading to increased cell survival, proliferation, and growth, but in some cells and tissues it regulates more specialized biological processes. Notably, PI3K is an obligate intermediate in the signaling pathway linking insulin's arrival at the cell surface to the regulation of glucose uptake and anabolic metabolism (reviewed in **ref. 2**). This chapter describes a method for quantifying the activation of the class 1A type PI3Ks by insulin.

Insulin stimulates all of its pleiotropic intracellular effects by activating the intrinsic tyrosine kinase activity of its receptor. The receptor phosphorylates several insulin receptor substrate proteins (IRS proteins) to produce phosphotyrosine binding sites for numerous proteins containing src homology 2 (SH2) domains, including the regulatory subunit of PI3K (**3**). By interacting with these phosphotyrosine moieties, this regulatory PI3K subunit, which is either 55 or 85 kDa in size, induces a conformational shift in the PI3K catalytic subunit (110 kDa), leading to its activation. Assays designed to assess PI3K activity involve the isolation by immunoprecipitation of this multiprotein complex that contains IRS proteins, the regulatory and catalytic domains of PI3K, and

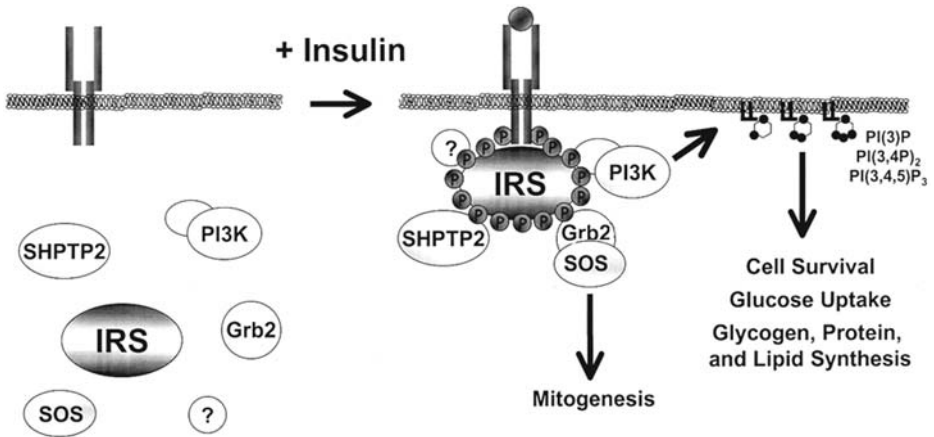

Fig. 1. Schematic diagram depicting the tyrosine phosphorylated IRS proteins recruiting and activating downstream effector molecules such as the adaptor protein Grb2, the tyrosine phosphatase SHPTP2, and PI3K.

others (*see Fig. 1*). Antibodies used for immunoprecipitation of this complex often include anti-phosphotyrosine or anti-IRS antibodies, which do not extract total cellular PI3K, but rather the amount of PI3K associated with newly tyrosine-phosphorylated proteins. Alternatively, one can also use antibodies against the p85 subunit of PI3K, which will also precipitate PI3K not bound to IRS proteins, to obtain a more accurate reflection of the degree of cellular PI3K activity. The catalytic activity of PI3K is then determined by measuring the incorporation of ^{32}P from $[\gamma\text{-}^{32}\text{P}]\text{ATP}$ into an exogenous phosphoinositide substrate. Phosphorylated lipids are extracted in an acidified chloroform/methanol solution, resolved by thin-layer chromatography (TLC), and detected by autoradiography. The method described in this chapter is optimized to measure the IRS-bound PI3K activity isolated from 3T3-L1 adipocytes, a model tissue culture system for evaluating insulin action.

1.1. Limitation of the PI3K Assay

A limitation of the PI3K assay described herein is that it might not reflect what is happening to 3'-phosphoinositide levels in some cells or tissues. For example, the activity of PI3K in a multiprotein complex may not correlate with the enzyme's activity in an intact cell. Alternatively, because 3'-phosphoinositides can be regulated by other mechanisms (e.g., dephosphorylation by a lipid phosphatase), an increase in PI3-kinase activity may not be indicative of an increase in cellular 3'-phosphoinositides. Wherever possible, the PI3K enzyme assay described herein should be complemented with studies designed to meas-

ure the intracellular production of 3'-phosphoinositides. One such method is to label cells or tissues with [^3H]inositol or [^{32}P O $_4$], extract and deacylate the lipids, and resolve the phosphoinositide head groups by high-performance liquid chromatography (HPLC) (4,5). Unfortunately, this method is both time-consuming and labor intensive. An alternative method for determining PI(3,4,5)P $_3$ levels quantifies the displacement of ^{32}P -labeled inositol(1,3,4,5)P $_4$ (IP $_4$) from a specific binding protein by IP $_4$ obtained from the alkaline hydrolysis of PI(3,4,5)P $_3$ in a cellular lipid extract (6,7). This mass assay is capable of detecting PI(3,4,5)P $_3$ at subpicomole levels. A final method involves transfecting cells with specific PH domains coupled to green fluorescent protein to label membrane domains enriched in particular 3'-phosphoinositides (5,8).

2. Materials

2.1. Reagents

1. Dulbecco's modified Eagle's-H21 medium, Leibovitz L-15 medium, fetal bovine serum, and calf serum can be obtained from Invitrogen (Carlsbad, CA).
2. Dexamethasone (Sigma) can be prepared as 4 mg/mL stock solution in ethanol that is stable for several months if stored at -20°C .
3. Isobutylmethylxanthine can be prepared as a 5 mM stock solution in isotonic saline. This will require boiling to dissolve, but can be filter sterilized and then frozen at -20°C in 50-mL aliquots until use.
4. Insulin solution: A stock insulin solution can be prepared by diluting enough insulin in 0.005 N HCl to make an approx 300 μM stock solution (approx 2mg/mL). The final insulin concentration should be determined by ultraviolet (UV) absorbance. This solution may be stored for several months at 4°C .
5. Lysis buffer: 50 mM Tris-HCl (pH 7.4), 150 mM NaCl, 1% Triton-X100, 20 mM sodium pyrophosphate, 200 mM sodium fluoride, 10 mM EDTA, 10% glycerol, 4 mM sodium orthovanadate, and protease inhibitors (*see Note 1*). The lysis buffer is stable for several months at 4°C , but the protease inhibitors should be added within 30 min of starting the experiment.
6. Protease inhibitors: One can use the "protease inhibitor cocktail for use with mammalian cell and tissue extracts" sold by Sigma (St. Louis, MO) or can individually add phenylmethylsulfonyl fluoride (PMSF, 1 mM), aprotinin (2 $\mu\text{g}/\text{mL}$), and leupeptin (10 $\mu\text{g}/\text{mL}$). PMSF can be made as a 100 mM stock in isopropanol, and an aliquot of aprotinin and leupeptin can be frozen as 1 : 1000 stock solutions prepared in water.
7. Protein assays: Members of our laboratory use the bicinchoninic acid (BCA) protein assay kit (Pierce Chemical Company, Rockford, IL), which is unaffected by the detergents in the lysis buffer, to determine protein concentrations.
8. Antibodies: Antibodies shown to be useful for the immunoprecipitation of PI3K activity include monoclonal anti-phosphotyrosine antibodies (clone 4G10 from Upstate Biotechnology Inc [UBI], Lake Placid, NY, and clone PY20 from Biomol

Research Laboratories, Inc., Plymouth Meeting, PA) (*see Note 2*), isoform specific anti-IRS (isoforms 1–4) antibodies (UBI), and anti-p85-PI3K antibodies (UBI). Agarose-conjugated protein-A or anti-mouse antibodies can be obtained from Santa Cruz Biotechnologies (Santa Cruz, CA) or Sigma (St. Louis, MO), respectively.

9. Wash buffer 1: Phosphate-buffered saline (PBS) with 1% igepal and 100 μM Na_3VO_4 .
10. Wash buffer 2: 100 mM Tris-HCl (pH 7.5), 500 mM LiCl, and 100 μM Na_3VO_4 .
11. Wash buffer 3 (TNE buffer): 10 mM Tris-HCl (pH 7.5), 100 mM NaCl, 1 mM EDTA, and 100 μM Na_3VO_4 . All buffers are stable at 4°C for several months, but the Na_3VO_4 should be added on the day of the experiment.
12. Phosphoinositide substrate: The most commonly used substrate for the PI3K assay is phosphatidylinositol (PI) (Avanti Polar Lipids, Alabaster, AL) (*see Note 3*), which can be stored at -20°C for several months as a 10 mg/mL stock solution in chloroform. Care should be taken to keep this in a tightly sealed tube or the chloroform will evaporate. The day of the experiment prepare a 2 mg/mL solution of phosphatidylinositol in TE buffer (Tris-HCl [pH 7.5], and 1 mM EGTA). To do this, dry the appropriate amount of PI under a stream of nitrogen and then resuspend in the necessary volume of TE by briefly sonicating in a bath sonicator (*see Note 4*).
13. ATP solution: To each kinase reaction is added 10 μL of ATP solution containing 30 μCi ^{32}P -ATP in a final concentration of MgATP (440 μM). Stock MgATP solutions can be stored as frozen aliquots for several months.
14. Stop solutions: Reactions are stopped by the sequential addition of (1) 8 M HCl and (2) chloroform/methanol (1 : 1, v/v). Both can be kept for several months at room temperature, but the latter must be sealed tightly to prevent evaporation.
15. TLC solvent system: For separation of ATP and PI(3)P by TLC use a solvent system composed of chloroform–methanol–water–ammonium hydroxide (60 : 47 : 11.3 : 2, v/v/v/v) (*see Note 5*).
16. 10 mM MgCl_2 .
17. 1% Potassium oxalate

2.2. Equipment

1. Labquake tube rotator from VWR Scientific (West Chester, PA)
2. TLC developing tank and silica gel 60 TLC plates from Merck (Darmstadt, Germany).
3. Storm 860 phosphorimager from Molecular Dynamics, Inc. (Sunnyvale, CA).

3. Methods

The experimental conditions described in this section are optimized for 3T3-L1 adipocytes, but the assay works well with numerous other cell types.

3.1. Cell Treatment and Lysis

1. 3T3-L1 preadipocytes are grown in 10-cm dishes in Dubelcco's modified Eagle's-H21 medium (DMEM) supplemented with 10% calf serum. Two days postconflu-

ence, the cells are differentiated into adipocytes by replacing the media with DMEM supplemented with 10% fetal bovine serum, 1 $\mu\text{g}/\text{mL}$ dexamethasone, and 112 $\mu\text{g}/\text{mL}$ isobutylmethylxanthine. After 3 d, cells are transferred to DMEM supplemented with 10% fetal bovine serum. Media should be replaced at least once a week. The cells can be used for the PI3K assays 7–35 d postdifferentiation. Use a 10-cm plate of differentiated 3T3-L1 adipocytes for each treatment condition.

2. Serum-deprive the cells by washing them in PBS and then incubating them in Leibovitz L-15 buffer supplemented with 0.2 % BSA for 2 h at 37°C.
3. Stimulate selected plates with insulin (100 nM final concentration) for 1–3 min (*see Note 6*); then, wash the cells with ice cold PBS. Remove the PBS by aspiration.
4. Immediately lyse the cells by adding 1 mL of ice-cold lysis buffer, scraping the cells off the plate, transferring them to a microfuge tube, and incubating them on ice for 20 min. Centrifuge the lysate for 10 min at 4°C at top speed in a microcentrifuge (20,800g). Transfer the supernatant to new microfuge tubes. Keep the lysates on ice while performing protein assays on each sample. One can still detect insulin-stimulated PI3K activity after freezing the lysates and storing at -20°C , but activity is lost after successive freeze–thaw cycles.

3.2. Immunoprecipitation of PI3-Kinase

1. PI3K assays are performed on extracts normalized to contain approx 500 μg cellular protein. To the appropriate amount of cleared lysate, add the amount of primary antibody recommended by the manufacturer for immunoprecipitation. Incubate for 1–3 h while rotating at 4°C using the Labquake tube rotator.
2. While the extract is incubating with the primary antibody, wash the agarose-conjugated protein-A or secondary antibody twice with the lysis buffer. Thirty microliters of a 1 : 1 slurry of the agarose-conjugated secondary antibody is sufficient to immunoprecipitate all of the primary antibody (*see Note 7*).
3. Add the lysates containing the primary antibody to the agarose-conjugated secondary antibody or protein-A. Incubate for 1 h while rotating at 4°C.
4. Wash the immunocomplexes three times with ice-cold wash buffer 1, three times with ice-cold wash buffer 2 (*see Note 8*), and twice with wash buffer 3 (TNE buffer). Use 1 mL of buffer for each wash. After each addition, pellet the sample in a minicentrifuge and remove the wash by aspiration.

3.3. PI3-Kinase Assay (Fig. 2)

1. Add 50 μL TNE buffer to each immunoprecipitate and resuspend the beads by tapping the side of the microfuge tube with a finger. Quickly add the following: (1) 10 μL of the phosphoinositides that were resuspended in the TE buffer (2 mg/mL) as described above; (2) 10 μL of 100 mM MgCl_2 , and (3) 10 μL of the ATP solution (30 μCi ^{32}P -ATP in 440 μM MgATP). Mix reagents by again tapping the side of the tube with a finger.
2. Allow the reaction to proceed for 10 min at room temperature (approx 22°C).

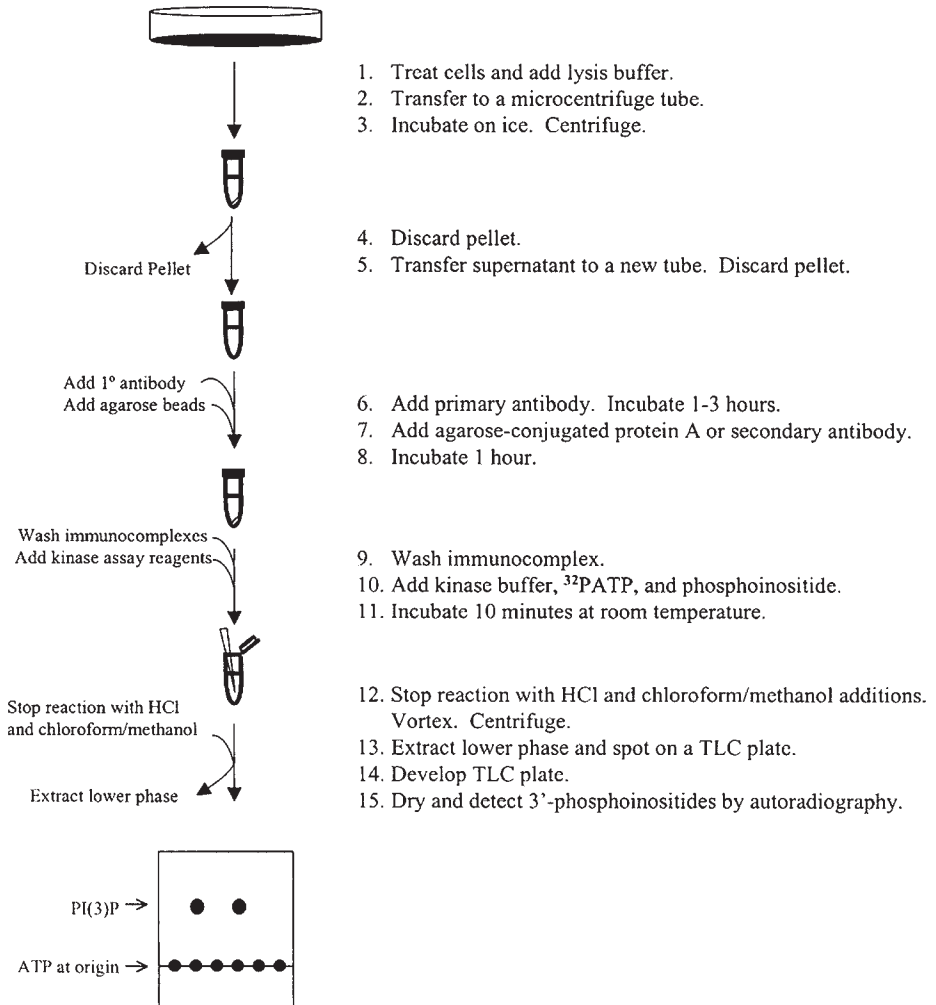

Fig. 2. Flowchart showing the major steps in the PI3K assay.

3. Stop the reaction by adding 20 μL of 8 M HCl followed immediately by 160 μL chloroform:methanol (1:1). The mixture will equilibrate into a lower organic phase and upper aqueous phase separated by a film containing the agarose beads.
4. Invert the tube to get good mixing; then, let it sit for several minutes at room temperature to allow the phases to separate. Ensure complete separation of the phases by centrifuging for 1 min at top speed in a microcentrifuge (approx 20,800g).
5. In a fume hood, transfer all of the lower phase to a new microfuge tube (*see Note 9*). This contains the ^{32}P -labeled phosphoinositides, which can be loaded immediately on a TLC plate or stored overnight at -20°C .

3.4. Thin-Layer Chromatography

1. Prepare TLC plates by coating them with a 1% potassium oxalate solution in water–methanol (1 : 1, v/v). This increases the charge on the plate and thus, the retention of charged compounds. To soak the plate, submerge it in the solution for approx 90 s (*see Note 10*). Dry the plate in an oven (approx 90–100°C).
2. With a pencil, lightly draw a horizontal line approx 3 cm from the bottom of the plate. Be careful not to scrape up any silica as you are writing on the plate. On the origin lane, mark locations to load each sample, separated by at least 1.5 cm.
3. Load the entire extract at the spot on the origin line. Add the sample in small aliquots (approx 20 μ L) and let each spot dry before adding the next one; this will prevent the sample from spreading out too much during loading. Do not let the sample occupy a region greater than 1 cm in diameter while loading, and do not touch the silica with the pipet tip. One may wish to load phosphoinositide standards to identify the phosphorylated products (*see Note 11*).
4. Develop the plate in the TLC tank using about 100 mL of the chloroform–methanol–water–ammonium hydroxide (60:47:11.3:2, v/v/v/v) solvent system (*see Note 5*). Allow the solvent migrate to within 1 cm of the top (approx 3 h).
5. Remove the plate from the tank and dry it in the fume hood.
6. Wrap the plate in plastic wrap and detect radioactivity by exposing it to either autoradiography film or a phosphorimager screen.

4. Notes

1. The first evidence that PI3K gets activated by tyrosine kinases came from studies on the soluble src kinase and the platelet-derived growth factor receptor (**9,10**). Although the lysis buffer used in these prior studies works well for the precipitation of either of these kinases, it is not optimal for the immunoprecipitation of IRS-associated PI3K (Whiteman and Birnbaum, unpublished observation). This is perhaps the result of an association of IRS proteins with the cytoskeleton following hormonal activation. **Figure 3** compares a conventional buffer (20 mM Tris-HCl [pH 7.5] containing 137 mM NaCl, 1 mM MgCl₂, 1 mM CaCl₂, and 100 μ M Na₃VO₄, 1% igepal [Sigma], and 10% glycerol) used for PI3K assays (**II**) with the one described herein.
2. One can mix the 4G10 and PY20 monoclonal anti-phosphotyrosine antibodies and use this cocktail in the immunoprecipitation.
3. Phosphatidylinositol is commonly used as a substrate in the PI3K assay. The lipid is inexpensive and easy to store, and its phosphorylated product, PI3P, is easily extracted from aqueous solutions and separated from ATP by TLC. However, the lipid can be a substrate for PI4- and PI5-kinases, and the lipid products produced by the phosphorylation of PI by these kinases, PI4P and PI5P, cannot be separated from PI3P using the TLC solvent system described herein. Thus, without the use of PI3K inhibitors, such as wortmannin or LY29002, one cannot confirm that the kinase being assayed is PI3K and not another PI-kinase. An alternative is to use PI(4,5)P₂ (Sigma), which can only be phosphorylated by PI3K. The charge makes it insoluble in chloroform and its product is harder to extract quantitatively from

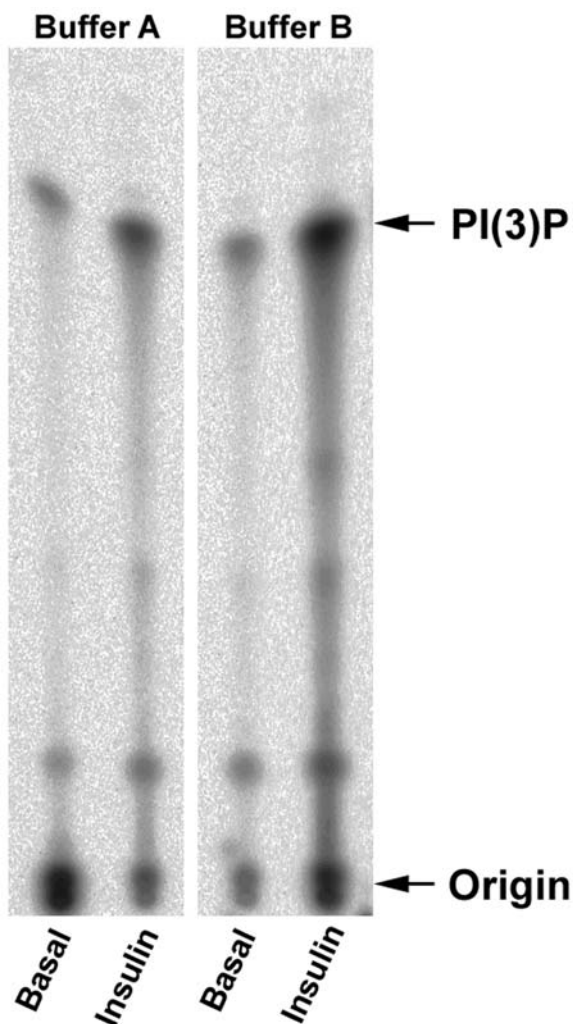

Fig. 3. Sample TLC plate showing the formation of PI(3)P produced by PI3K. PI3K activity was immunoprecipitated from 3T3-L1 adipocytes treated with or without insulin as described in the text. Buffer A is the buffer described herein, whereas buffer B is the conventional buffer described in Note 1.

aqueous solutions and more difficult to separate from ATP by TLC. Also, this lipid does not form vesicles following sonication in TE buffer. To store PI(4,5)P₂, resuspend it in a chloroform–methanol–water (5 : 10 : 2, v/v/v) solution. To suspend in vesicles, mix PI(4,5)P₂ 1 : 1 with another carrier lipid, such as phosphatidylserine. Some investigators use equal amounts of all three phosphoinositide substrates [i.e., PI, PI(4)P, PI(4,5)P₂] plus phosphatidylserine, which will lead to the formation of

- three different products after the PI3K assay. See **Note 5** regarding differences in TLC solvent systems if using PI(4,5)P₂ as a substrate.
4. The dried lipids will form a visible film on the bottom of the microcentrifuge tube. During sonication the solution will initially turn cloudy and then clear as lipid-vesicles form. The film on the bottom of the tube will noticeably disappear.
 5. If using PI(4,5)P₂ as a substrate, prepare a solvent system composed of 1-propanol/acetic acid–water (65:4.1:30.9, v/v/v) (**12**).
 6. In 3T3-L1 adipocytes, insulin-stimulated PI3K activity is maximal within 1 min and remains elevated for hours (**13**). By contrast, some growth factors, such as platelet-derived growth factor, cause a more transient increase in PI3K activity (**13**). We recommend 1–5 min, because this is the peak time for both insulin and other growth factors. For other agonists, this must be determined empirically.
 7. Although the amount of protein-A–agarose used in the immunoprecipitation here is sufficient to precipitate the entire amount of primary antibody in the lysate, some researchers have difficulty seeing this relatively small amount. This increases the likelihood of accidentally aspirating some of the beads. One can either add excess agarose conjugated to protein-A or anti-mouse antibodies, or, as an less expensive, add unconjugated agarose to help with visualizing the immunoprecipitate.
 8. The wash with high concentrations of lithium is included to inhibit inositol phosphatases (**14**).
 9. The aqueous phase contains most of the free [³²P]ATP, which will show up as a large origin on the TLC plate. This is not problematic for analysis but is not as aesthetically pleasing, particularly if the size of the ATP spot at the origin varies greatly between samples. To extract the lower phase, depress the plunger of a p100 Pipetman (Rainin, Emeryville, CA) almost all of the way and then move the tip through the upper aqueous phase and the layer of agarose beads at the interphase. Depress the plunger the rest of the way to eject the drop of aqueous phase that entered the tip as it moved through the upper layer. Slowly release the plunger to draw the lower phase into the Pipetman and transfer it to a new microfuge tube. Extract 20–30 μL each time, and repeat until the lower phase is completely removed.
 10. The TLC plate can also be saturated with potassium oxalate by allowing the oxalate solution to travel up the plate in a TLC developing tank. The oxalate solution can also be made in pure methanol, which will shorten the drying time.
 11. The final lipid products are easy to identify. For PI(3)P, it is the highest migrating phosphorylated species. One can, however, load lipid standards that are available commercially from Avanti Polar Lipids (Alabaster, AL) and Echelon Research Labs (Salt Lake City, UT) on adjacent lanes. To detect these standards, place the TLC plate in a sealed chamber with iodine and allow the lipids to be stained by the iodine vapor.

Acknowledgments

The authors acknowledge Eileen Whiteman and Morris Birnbaum from the University of Pennsylvania for sharing experiences and findings with the assay. The work of this laboratory is supported by the American Diabetes Association (Career Development Award to SAS), March of Dimes (Basil O'Connor Starter

Scholar's Award to SAS), American Heart Association (Beginning Grant-in-Aid to SAS), and the National Institutes of Health (R01-DK58784).

References

1. Katso, R., Okkenhaug, K., Ahmadi, K., White, S., Timms, J., and Waterfield, M. D. (2001) Cellular function of phosphoinositide 3-kinases: implications for development, homeostasis, and cancer. *Annu. Rev. Cell. Dev. Biol.* **17**, 615–675.
2. Shepherd, P. R., Withers, D. J., and Siddle, K. (1998) Phosphoinositide 3-kinase: the key switch mechanism in insulin signalling. *Biochem. J.* **333**, 471–490.
3. White, M. F. (1998) The IRS-signaling system: a network of docking proteins that mediate insulin and cytokine action. *Recent Prog. Horm. Res.* **53**, 119–138.
4. Hama, H., Takemoto, J. Y., and DeWald, D. B. (2000) Analysis of phosphoinositides in protein trafficking. *Methods* **20**, 465–473.
5. Stratford, S., DeWald, D. B., and Summers, S. A. (2001) Ceramide dissociates 3'-phosphoinositide production from pleckstrin homology domain translocation. *Biochem. J.* **354**, 359–368.
6. van der Kaay, J., Cullen, P. J., and Downes, C. P. (1998) Phosphatidylinositol(3,4,5)trisphosphate (Ptdins(3,4,5)P3) mass measurement using a radioligand displacement assay. *Methods Mol. Biol.* **105**, 109–125.
7. van der Kaay, J., Batty, I. H., Cross, D. A., Watt, P. W., and Downes, C. P. (1997) A novel, rapid, and highly sensitive mass assay for phosphatidylinositol 3,4,5-trisphosphate (PtdIns(3,4,5)P3) and its application to measure insulin-stimulated PtdIns(3,4,5)P3 production in rat skeletal muscle in vivo. *J. Biol. Chem.* **272**, 5477–5481.
8. Kavran, J. M., Klein, D. E., Lee, A., Falasca, M., Isakoff, S. J., Skolnik, E. Y., et al. (1998) Specificity and promiscuity in phosphoinositide binding by pleckstrin homology domains. *J. Biol. Chem.* **273**, 30,497–30,508.
9. Kaplan, D. R., Whitman, M., Schaffhausen, B., Pallas, D. C., White, M., Cantley, L., et al. (1987) Common elements in growth factor stimulation and oncogenic transformation: 85 kd phosphoprotein and phosphatidylinositol kinase activity. *Cell* **50**, 1021–1029.
10. Courtneidge, S. A. and Heber, A. (1987) An 81 kd protein complexed with middle T antigen and pp60c-src: a possible phosphatidylinositol kinase. *Cell* **50**, 1031–1037.
11. Sun, X. J., Rothenberg, P., Kahn, C. R., Backer, J. M., Araki, E., Wilden, P. A., et al. (1991) Structure of the insulin receptor substrate IRS-1 defines a unique signal transduction protein. *Nature* **352**, 73–77.
12. Chen, K. S., Friel, J. C., and Ruderman, N. B. (1993) Regulation of phosphatidylinositol 3-kinase by insulin in rat skeletal muscle. *Am. J. Physiol.* **265**, E736–E742.
13. Staubs, P. A., Nelson, J. G., Reichart, D. R., and Olefsky, J. M. (1998) Platelet-derived growth factor inhibits insulin stimulation of insulin receptor substrate-1-associated phosphatidylinositol 3-kinase in 3T3-L1 adipocytes without affecting glucose transport. *J. Biol. Chem.* **273**, 25,139–25,147.
14. Hallcher, L. M. and Sherman, W. R. (1980) The effects of lithium ion and other agents on the activity of myo-inositol-1-phosphatase from bovine brain. *J. Biol. Chem.* **255**, 10,896–10,901.

Assaying AKT/Protein Kinase B Activity

Kyle L. Hoehn and Scott A. Summers

1. Introduction

Akt/protein kinase B (PKB) is a serine/threonine kinase that mediates many of the anabolic actions of insulin (**1**), as well as the growth-promoting and/or anti-apoptotic effects of other growth factors, cytokines, or transforming oncogenes (**2**). These agonists all stimulate Akt/PKB by promoting its phosphorylation on two regulatory residues (e.g., S473 and T308 for the Akt1 isoform), an event dependent on the prior activation of a signaling pathway initiated by the lipid kinase phosphatidylinositol 3-kinase. Once Akt/PKB is activated, it phosphorylates numerous different substrates, including transcription factors (e.g., FKHR1, others), anti-apoptotic enzymes (e.g., Bad, caspase-9), and metabolic enzymes (e.g., glycogen synthase kinase 3 β), to regulate this diverse array of biological processes. Herein we describe a method for measuring the catalytic activity of Akt/PKB isolated from cell or tissue extracts by quantifying its ability to catalyze phosphate incorporation into an exogenous substrate (outlined in **Fig. 1**). This chapter illustrates techniques for immunoprecipitating Akt/PKB, choosing an appropriate substrate for the reaction, and optimizing the assay conditions.

Although recombinant Akt/PKB can be prepared using baculovirus (**3**), most researchers are interested in measuring the activity of Akt/PKB in tissues or cultured cells. Akt/PKB is typically isolated from these tissues by immunoprecipitation, and a variety of antibodies raised against the Akt/PKB regulatory domain can be used to extract Akt/PKB from cell and tissue lysates without affecting its catalytic activity. Alternatively, many researchers choose to evaluate the activity of wild-type or mutant forms of Akt/PKB that have been over-expressed in different cell lines. For example, Akt/PKB can be epitope-tagged

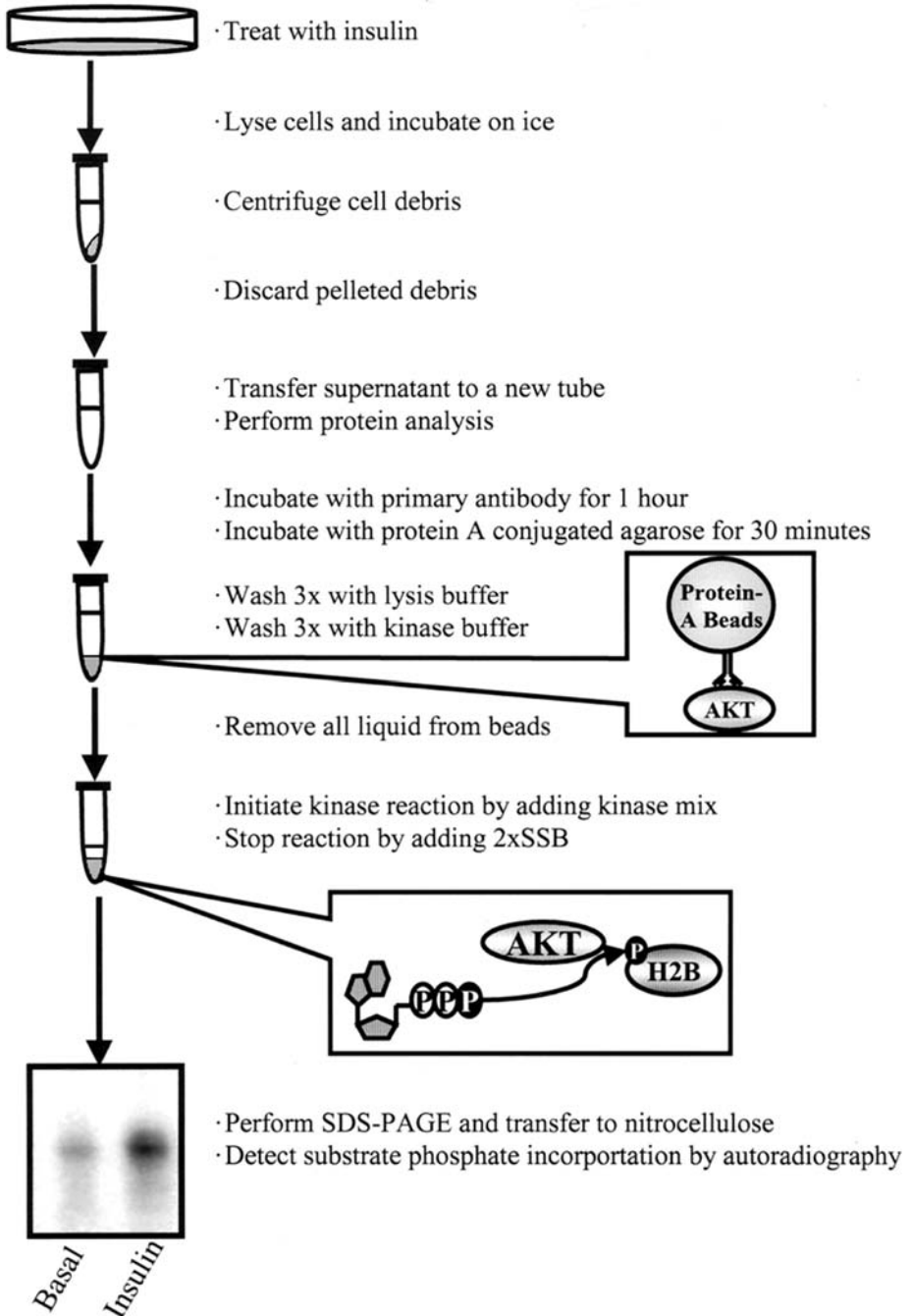

Fig. 1. Schematic diagram depicting the major steps in the Akt/PKB kinase assay.

on either its amino or carboxyl terminus and can then be immunoprecipitated with antibodies recognizing the epitope (4,5).

Akt/PKB phosphorylates a wide variety of cellular proteins *in vivo* and can phosphorylate histone H2B and several engineered peptides *in vitro*. The choice of substrate for the Akt/PKB kinase reactions largely depends on the method to be used for detecting phosphate incorporation. One can monitor *in vitro* Akt kinase activity by quantifying the amount of radioactive phosphate transferred from [γ - 32 P]ATP into the substrate protein or, alternatively, by immunodetecting newly phosphorylated Akt substrates with phospho-specific antibodies. The radioactive method will work with multiple different substrates. Histone-2B (H2B) was one of the first proteins used to measure Akt/PKB's catalytic activity and is used frequently because it is commercially available and relatively inexpensive. However, H2B is not exclusively phosphorylated by Akt/PKB, which could prove problematic should contaminants, such as cAMP- or cGMP-activated protein kinases, coprecipitate alongside Akt/PKB. As will be shown, more specific substrates, such as glycogen synthase kinase-3 β (GSK3 β), work equally well in the radioactive assay (*see Fig. 2*). Alternatively, if using GSK3 β or Bad as a substrate, one can detect the phosphorylated product using commercially available antibodies recognizing the phosphorylated form. Immunodetection with a phospho-specific antibody precludes the necessity of using radioactive ATP for detecting phosphate incorporation. Regardless of which substrate is used, sufficient quantities must be added to keep the reaction in the linear range of enzyme activity. Under the conditions to be described, most of the substrate can be phosphorylated within 10 min of the addition of ATP.

Wherever possible, the *in vitro* assay described herein should be complemented with studies assessing Akt/PKB regulation and/or activity *in vivo*. Specifically, the phosphorylation state of Akt/PKB can be assessed by immunoblotting cell lysates with phospho-specific antibodies against either regulatory residue (antibodies available from New England Biolabs, Beverly, MA, Biosource International, Camarillo, CA, and others). Alternatively, the activity of Akt/PKB can be assessed by immunoblotting cell lysates with phospho-specific antibodies that recognize various Akt substrates (e.g., phospho-BAD, phospho-GSK3 β , and phospho-Akt-substrate panel antibodies from New England Biolabs).

2. Materials

2.1. Reagents

The protocol describes the measurement of Akt/PKB kinase activity in cultured 3T3-L1 adipocytes, a model cell line used for studying insulin-stimulated signal transduction and metabolism. The following reagents are used for the maintenance and differentiation of the 3T3-L1 line.

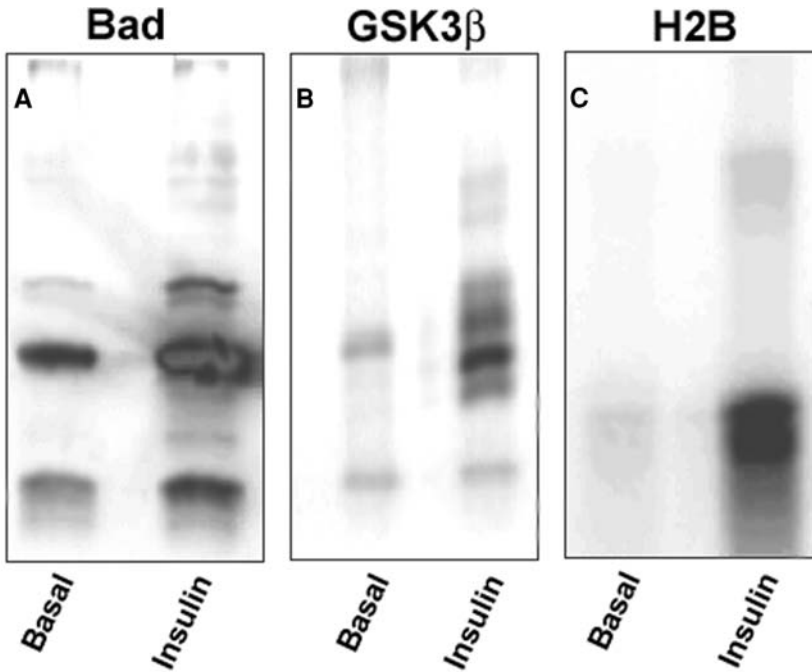

Fig. 2. Example kinase assay done using three different Akt/PKB substrates. Assays were performed as described in the text using 3T3-L1 preadipocytes treated with or without insulin as indicated. **(A)** Assay was performed using Bad as a substrate, and detection was performed using the phospho-Bad antibody. The top band is the full-length recombinant 31-kDa protein, and the lower band is degradation product. **(B)** Recombinant GSK3 β was used as a substrate, and the amount of phosphate transferred into GSK3 β from [γ - 32 P]ATP was determined by autoradiogram. **(C)** Histone H2B was used as a substrate, and the amount of phosphate transferred into H2B from [γ - 32 P]ATP was determined by autoradiogram.

1. Dulbecco's modified Eagle's-H21 medium, Leibovitz L-15 medium, fetal bovine serum, and calf serum can be obtained from Invitrogen (Carlsbad, CA).
2. Dexamethasone can be prepared as a 4 mg/mL stock solution in ethanol; this is stable for several months if stored at -20°C .
3. Isobutylmethylxanthine can be prepared as a 5 mM stock solution in isotonic saline; this will require boiling to dissolve, but can be filter-sterilized and then stored at -20°C until use.
4. Insulin solution: A stock insulin solution can be prepared by diluting enough insulin in 0.005 N HCl to make an approx 300 μM stock solution. The final insulin concentration should be determined by ultraviolet (UV) absorbance. This solution may be stored for several months at 4°C .

5. Lysis buffer: 20 mM Tris-HCl (pH 7.2), 150 mM sodium chloride, 10% glycerol, 1% igepal, 10 mM sodium fluoride, 30 mM sodium pyrophosphate, and 1 mM EDTA. This solution can be stored for 6 mo when filter-sterilized and kept at 4°C. The following protease and phosphatase inhibitors must be added fresh: 1 mM Na₃VO₄, 1 mM polymethylsufonyl fluoride (PMSF), 10 µg/mL leupeptin, and 2 µg/mL aprotinin (see **Note 1**).
6. Protein assays: Protein concentrations should be determined using a method that is unaffected by detergents found in the lysis buffer. We use the bicinchoninic acid (BCA) protein assay kit from Pierce Chemical Company (Rockford, IL).
7. Antibodies: Isoform-specific anti-Akt antibodies generated against a regulatory domain near the carboxyl terminus are available from Upstate Biotechnology, Inc. (Lake Placid, NY). New England Biolabs also sells antibodies recognizing different Akt/PKB isoforms, as well as antibodies recognizing the phosphorylated form of the enzyme (**4,6**). Agarose-conjugated protein-A and/or secondary antibodies used to extract the antibody bound Akt from the lysate are available from Santa Cruz Biotechnology (Santa Cruz, CA) (see **Note 2**).
8. Substrate: Histone H2B can be purchased from Roche Applied Science (Indianapolis, IN) and Bad can be purchased from Upstate Biotechnology, Inc. GSK3β can be produced as a recombinant fusion protein with glutathione-S-transferase using standard techniques. Substrates can be stored in 50% glycerol at -20°C. If using histone H2B, include 25 µg per reaction. For GST-GSK3β or Bad, use 15 µg or 3 µg per reaction, respectively.
9. Kinase reaction solutions: Prepare a 20X kinase buffer (pH 7.2) containing 400 mM HEPES and 100 mM MgCl₂. This solution can be stored for several months at 20°C. Prepare the following kinase mix the day of the experiment: 1 mM dithiothreitol (DTT), 10 µM MgATP, 200 µM EGTA, 2 µg protein kinase inhibitor, and the appropriate amount of substrate. Ten microliters of this kinase mix containing 5 µCi of 6000 Ci/mMol [γ ³²P] ATP is added to each reaction (see **Note 3**). The DTT and EGTA can be kept as 100X stock solutions, and the MgATP can be frozen as a 100X stock. All reagents can be obtained from Sigma (St. Louis, MO).
10. Sample solubilization buffer (SSB) (2X stock): 125 mM Tris-HCl (pH 6.8), 5.5% sodium dodecyl sulfate (SDS), 20% glycerol, 10% β-mercaptoethanol, and 0.006% bromophenol blue.

2.2. Equipment

1. Labquake tube rotator from VWR Scientific (West Chester, PA).
2. Gel electrophoresis unit from Amersham Pharmacia (San Francisco, CA).
3. Storm 860 phosphorimager from Molecular Dynamics, Inc. (Sunnyvale, CA).

3. Methods

The following protocol describes the measurement of Akt/PKB activity in insulin-stimulated 3T3-L1 adipocytes (see **Fig. 1**), but it is applicable to studies evaluating Akt/PKB activity in numerous cells or tissues treated with a variety of different cellular agonists.

3.1. Cell Treatment

1. Split 3T3-L1 preadipocytes into 6-cm dishes in Dulbecco's modified Eagle's-H21 medium (DMEM) supplemented with 10% calf serum. Two days postconfluence, differentiate the cells into adipocytes by replacing the media with DMEM medium supplemented with 10% fetal bovine serum, 1 $\mu\text{g}/\text{mL}$ dexamethasone, and 112 $\mu\text{g}/\text{mL}$ isobutylmethylxanthine. After 3 d, replace the media with DMEM supplemented with 10% fetal bovine serum. Thereafter, replace the media at least once a week. The cells can be used for the Akt/PKB assays up to 35 d postdifferentiation.
2. Use a 6-cm plate of differentiated 3T3-L1 adipocytes for each treatment condition. Serum-deprive the cells by washing them in phosphate-buffered saline (PBS) and then incubating them for 2 h at 37°C in Leibovitz L-15 buffer supplemented with 0.2% BSA.
3. Stimulate selected dishes of cells with insulin (100 nM final concentration) for 10 min. Quickly wash the cells twice with ice-cold PBS.

3.2. Cell Lysis

1. Lyse the cells by adding 1 mL of ice-cold lysis buffer containing protease inhibitors.
2. Scrape the cells off the plate, transfer them to a microcentrifuge tube, and incubate them on ice for 10 min.
3. Centrifuge the lysate for 10 min at 4°C at top speed in a microcentrifuge (20,800g). Transfer the supernatant to new microcentrifuge tubes.
4. Perform a protein assay while keeping all samples on ice (*see Note 4*).

3.3. Immunoprecipitation

1. Perform immunoprecipitations on lysates normalized to contain equal quantities of cellular protein. Aliquot lysate containing approx 300 μg protein into a labeled microcentrifuge tube and then dilute with lysis buffer containing protease inhibitors to bring the lysate up to a total volume of 500 μL .
2. Start the immunoprecipitation by adding the amount of antibody suggested by the manufacturer for immunoprecipitation. Rotate the tubes at 4°C for at least 1 h.
3. For each treatment condition, aliquot 50 μL of a 1:1 slurry of protein-A conjugated to agarose beads (or secondary antibody conjugated to agarose beads) into a new labeled microcentrifuge tube.
4. Wash the beads three times with 1 mL of ice-cold lysis buffer containing protease inhibitors. Pellet the beads by centrifuging in a benchtop picofuge after the addition of each wash. After the last wash, remove most of the fluid, leaving a very small volume above the beads.
5. Add the cell lysates containing the primary antibody to each of the new tubes containing the agarose-conjugated protein-A. Rotate this mixture at 4°C for at least 30 min.

6. During the incubation with the protein-A, thaw out the 20X kinase buffer. Prepare at least 3 mL of 1× kinase buffer and 25 μ L of 1.5X kinase buffer for each reaction being performed.
7. After the 30-min incubation is complete, pellet the beads by centrifuging at 6000g for 30 s. Remove the supernatant.
8. Wash the beads three times with ice-cold lysis buffer containing protease inhibitors, then three times with 1× kinase buffer. Use approx 1 mL for each wash. Completely remove all liquid after the last wash (*see Note 5*).
9. Add 20 μ L of 1.5× kinase buffer to the beads.

3.4. Kinase Reaction

1. Start the reaction by adding 10 μ L of kinase mix containing the 5 μ Ci [γ - 32 P] ATP to each reaction tube (*see Note 3*). This effectively dilutes the 1.5X kinase buffer to 1×. Suspend the beads by tapping the bottom of the tube.
2. Allow the reaction to proceed for 5 min at 30°C; then, stop the reaction by adding 30 μ L of 2X SSB (*see Note 6*).
3. Incubate the samples at 95°C for 2 min; then, spin at maximum speed (approx 20,800g) in a microcentrifuge.

3.5. Electrophoresis

1. Load half of the reaction on a 12.5% sodium dodecyl sulfate–polyacrylamide gel electrophoresis (SDS-PAGE) gel (*see Note 7*). Run the gel until the dye front is at the bottom of the gel. If you are doing a radioactive assay, do not let the dye front run off of the bottom of the gel; this contains the free [32 P]ATP. Cut the dye front off of the gel using a razor blade.
2. Transfer the proteins in the gel to nitrocellulose (*see Note 8*).
3. If doing the radioactive assay, quantify 32 P incorporation into the substrate by autoradiography using a phosphorimager. If doing the nonradioactive assay, detect phosphate incorporation with the phospho-specific antibody by immunoblotting. We use the enhanced chemiluminescence kit from Amersham Biosciences (Piscataway, NJ) for visualization of the secondary antibody.

4. Notes

1. The protease inhibitors aprotinin, leupeptin, and PMSF can be replaced with a commercial protease inhibitor cocktail.
2. For nonradioactive detection of phosphate incorporation into Bad, we use a phospho-specific antibody against the S136 phosphorylation site from Upstate Biotechnologies, Inc. For nonradioactive detection of phosphate incorporation into GSK3 β , we use a phospho-specific antibody against the serine-9 phosphorylation site from Cell Signaling (Beverly, MA).
3. If you have chosen to detect substrate phosphorylation by the nonradioactive method (i.e. using a phospho-specific antibody), you do not need to add the [32 P]-labeled ATP.

4. If necessary, one can stop at this point and store the extracts at -20°C without losing much kinase activity. If this is to be done, snap-freeze the cell lysates in liquid nitrogen.
5. To remove all of the liquid from the beads after the last wash, attach a small-gauge needle (27G) to the vacuum apparatus and insert the needle down the side of the tube into the beads. This will remove all excess liquid, but will not disturb the beads. Quickly add the 20 μL of $1.5\times$ kinase buffer (so that the beads do not dry out) and proceed to the kinase reaction.
6. If you are performing the assay on many samples, consider starting and stopping the reactions at 20-s intervals to keep the timing consistent. The Akt/PKB reaction proceeds quickly, and it is thus important to determine that the Akt/PKB is not phosphorylating all of the substrate in the mixture before completion of the reaction. The timing may vary depending on source of Akt/PKB, amount of enzyme precipitated, and the substrate used. Under the above-described conditions, the reaction proceeds rather quickly; 5 min is sufficient to put the kinase reaction in the middle of the linear range for H2B phosphorylation.
7. When loading the gel, it is best to skip a lane between each sample so that the signals do not overlap. Also, when loading the samples, try not to load the beads onto the gel.
8. We find that we obtain less background signal if we transfer the blot to nitrocellulose, rather than drying the gel.

References

1. Summers, S. A., Whiteman, E. L., and Birnbaum, M. J. (2000) Insulin signaling in the adipocyte. *Int. J. Obes. Relat. Metab. Disord.* **24**, S67–S70.
2. Brazil, D. P. and Hemmings, B. A. (2001) Ten years of protein kinase B signalling: a hard Akt to follow. *Trends Biochem. Sci.* **26**, 657–664.
3. Fabbro, D., Batt, D., Rose, P., Schacher, B., Roberts, T. M., and Ferrari, S. (1999) Homogeneous purification of human recombinant GST-Akt/PKB from Sf9 cells. *Protein Expr. Purif.* **17**, 83–88.
4. Summers, S. A., Whiteman, E. L., Cho, H., Lipfert, L., and Birnbaum, M. J. (1999) Differentiation-dependent suppression of platelet-derived growth factor signaling in cultured adipocytes. *J. Biol. Chem.* **274**, 23,858–23,867.
5. Sun, M., Wang, G., Paciga, J. E., Feldman, R. I., Yuan, Z. Q., Ma, X. L., et al. (2001) AKT1/PKBalpha kinase is frequently elevated in human cancers and its constitutive activation is required for oncogenic transformation in NIH3T3 cells. *Am. J. Pathol.* **159**, 431–437.
6. Summers, S. A., Garza, L. A., Zhou, H., and Birnbaum, M. J. (1998) Regulation of insulin-stimulated glucose transporter GLUT4 translocation and Akt kinase activity by ceramide. *Mol. Cell. Biol.* **18**, 5457–5464.

16

**Measurements of Cellular Phosphoinositide Levels
in 3T3-L1 Adipocytes**

Daryll B. DeWald

1. Introduction

Phosphoinositides are a family of minor membrane phospholipids that have important roles in cell signaling pathways. Seven phosphoinositides have been identified in eukaryotic cells (all are found in 3T3-L1 cells), including phosphatidylinositol 3-phosphate [PtdIns(3)P], phosphatidylinositol 4-phosphate [PtdIns(4)P], phosphatidylinositol 5-phosphate [PtdIns(5)P], phosphatidylinositol 3,4-bisphosphate [PtdIns(3,4)P₂], phosphatidylinositol 3,5-bisphosphate [PtdIns(3,5)P₂], phosphatidylinositol 4,5-bisphosphate [PtdIns(4,5)P₂], and phosphatidylinositol 3,4,5-trisphosphate [PtdIns(3,4,5)P₃]. PtdIns(3)P and PtdIns(4)P are the products of phosphatidylinositol 3-kinase and phosphatidylinositol 4-kinase action. In eukaryotic cells, PtdIns(3)P and PtdIns(4)P have critical roles in membrane transport. PtdIns(5)P has been identified at low concentrations in some eukaryotic cells, but its role is unknown. PtdIns(4,5)P₂ can be produced by the action of PtdIns 4- or 5-kinases on PtdIns(5)P or PtdIns(4)P, respectively, and is involved in signaling via G-protein-coupled receptors, regulating vesicle-mediated protein traffic, and actin filament polymerization. PtdIns(4,5)P₂ also serves as a precursor for inositol 1,4,5-trisphosphate that is known to cause cytosolic calcium mobilization in some cell types. PtdIns(3,5)P₂ is produced via phosphatidylinositol 5-kinase action on PtdIns(3)P and has roles in membrane transport and stress signaling. PtdIns(3,4)P₂ and PtdIns(3,4,5)P₃ are found at nominal levels in some unstimulated mammalian cells and their levels can increase rapidly following growth factor receptor and phosphatidylinositol 3-kinase activation. In 3T3-L1 cells, PtdIns(3,4)P₂ and PtdIns(3,4,5)P₃ serve as sig-

naling molecules following growth factor stimulation and their production correlates with adipogenesis, glucose uptake, and modification of gene expression.

Quantifying the levels of adipocyte phosphoinositides is critical to understanding their role in cellular signaling pathways. Numerous studies have focused on the role of phosphoinositides in 3T3-L1 cells, and some provide technical approaches to quantify phosphoinositide levels in these cells (1–8). Probably the most commonly used procedure for approximating the concentrations of phosphoinositides in mammalian cells is to analyze the relative extractable phosphoinositide kinase activities. This is accomplished by extracting phosphoinositide kinases and performing *in vitro* assays where substrates are phosphatidylinositol or phosphoinositide precursors. Products of these *in vitro* reactions are then analyzed by thin-layer chromatography (TLC) or deacylated and analyzed by high-performance liquid chromatography (HPLC). In spite of its usefulness revealing relative activities of different phosphoinositide kinases, this technique does not indicate the quantities of phosphoinositides *in vivo*.

Two other methodologies provide qualitative indicators of phosphoinositide concentrations in cells: (1) green-fluorescent protein :phosphoinositide-binding domain (e.g., pleckstrin homology and FYVE) fusion proteins expressed in cells have been used to determine the localization of particular phosphoinositides in living cells and (2) monoclonal antibodies directed against phosphoinositides [PtdIns(4,5)P₂ and PtdIns(3,4,5)P₃] have been used to determine their localization in fixed cells. Both of these approaches provide information about the localization and relative concentration of specific phosphoinositides, but neither provides an assessment of the concentration of all the phosphoinositides found in 3T3-L1 cells.

The method described in this chapter is the standard for measurement of extractable phosphoinositides from 3T3-L1 cells. Cells are metabolically labeled to steady state with a radiolabeled precursor (*myo*-³H-inositol or ³²P-ATP) that incorporates into phosphoinositides. Cellular lipids are then extracted and the lipids are analyzed by TLC or preferably they are deacylated and glycerophosphoinositol “headgroups” released and resolved on anion-exchange HPLC. The quantities of glycerophosphoinositols, determined by counts (dpm) in the respective peaks, represent the levels of phosphoinositides in the cells. With proper controls, the relative and molar concentrations of all seven phosphoinositides can be determined at the same time for each cell sample.

2. Materials

2.1. Reagents

1. Dulbecco's modified Eagle's medium (DMEM) containing 10% calf serum is used to culture 3T3-L1 cells. Inositol-free DMEM containing *myo*-(2-³H)-inositol and

- 10% calf serum should be used for labeling cellular phosphoinositides. DMEM, inositol-free DMEM, and calf serum are products of Gibco (Hyclone, Logan, UT).
2. HPLC-grade acetic acid, *n*-butanol, chloroform, ethanol, methanol, pyridine, petroleum ether, diethyl ether, and ethyl formate can be obtained from Fisher Scientific (Pittsburgh, PA). Trichloroacetic acid and ammonium phosphate can also be obtained from Fisher Scientific. Methylamine (40% solution) should be obtained from Acros Organics (Fisher Scientific).
 3. γ - ^{32}P -ATP and *myo*-(2- ^3H)-inositol for labeling cells can be obtained from Amersham Biosciences (Piscataway, NJ). Phosphatidylinositol 4,5-bisphosphate [inositol-2- ^3H (N)]-(PtdIns(4,5)P₂] standard can be obtained from Perkin-Elmer (Boston, MA). This standard can be deacylated for the HPLC analyses. Phosphatidylinositol and phosphoinositides used for in vitro kinase assays and as standards on TLC can be obtained from Echelon Biosciences Inc. (Salt Lake City, UT).
 4. Insulin and platelet-derived growth factor (PDGF) for cell-stimulation experiments can be obtained from Calbiochem (San Diego, CA).
 5. TLC Silica Gel 60 plates can be purchased from EM Sciences (Gibbstown, NJ).
 6. Strong anion-exchange Partisil 5 SAX (4.6 × 250 mm) or Partisil 10 SAX (4.6 × 250 mm) columns from Whatman (Ann Arbor, MI) should be fitted with strong anion-exchange guard columns (Phenomenex, Torrance, CA).
 7. EcoLume (ICN Research Products, Costa Mesa, CA) or equivalent scintillation fluid should be mixed with eluted fractions prior to counting.

2.2. Equipment

1. The most convenient way to dry samples is with a SpeedVac (Savant Instruments, Farmingdale, NY) fitted with a charcoal and cold trap.
2. HPLC can be performed using a Beckman (Fullerton, CA) System Gold chromatograph equipped with an ultraviolet (UV) detector and Beckman System Gold Software.
3. HPLC fractions can be collected with an ISCO Foxy 200 (Lincoln, NE) or equivalent fraction collector; a fraction collector with racks that will hold scintillation vials is convenient.
4. For sonication of the samples, use a bath sonicator (Branson 2510, Branson Ultrasonics, Danbury, CT)

3. Methods

In vivo phosphoinositide concentrations from actively growing 3T3-L1 cells can be determined using the general scheme depicted in **Fig. 1**.

3.1. 3T3-L1 Preadipocyte/Adipocyte Tissue Culture

1. 3T3-L1 preadipocytes or adipocytes should be grown to at least 60% confluency in 75-cm² flasks (6 mL of medium).
2. The medium (DMEM +10% calf serum) should be decanted from flasks and cells should be washed with fresh inositol-free DMEM +10% calf serum and cultured in

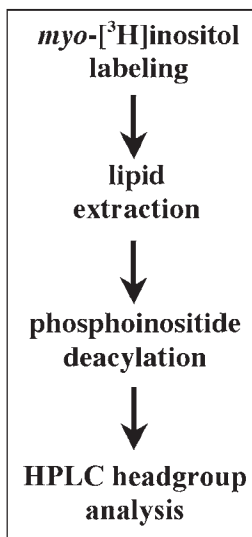

Fig. 1. Scheme for the determination of phosphoinositide concentrations in 3T3-L1 cells. Actively dividing 3T3-L1 cells are metabolically labeled, then, total lipids are extracted and deacylated and analyzed using strong anion, exchange HPLC, as described in the text.

this inositol-free medium. *myo*-(2-³H)-Inositol label should be added to the medium and cells cultured for 24 h.

3. After labeling the cells for this period, the medium should be replaced and labeling continued for an additional 24 h.
4. To stimulate the cellular synthesis of PtdIns(3,4)P₂ and PtdIns(3,4,5)P₃, 3T3-L1 cells should be incubated for an additional 2-h period in an inositol-free and serum-free DMEM containing 0.2% bovine serum albumin (BSA) and 10 μ Ci/mL *myo*-(2-³H)-inositol. Cells can then be stimulated with 20–50 ng/mL PDGF or 100 nM insulin for 3, 5, 15, or 30 min, which will stimulate them to synthesize PtdIns(3,4)P₂ and PtdIns(3,4,5)P₃.

3.2. Cell Harvest

1. To stop stimulation and block cellular phosphatase and lipase activity, ice-cold TCA should be added to the medium in the flasks to a final concentration of 10%. Flasks containing the 10% TCA fixing solution should be on ice for 30–90 min. This solution should cover the cells during **steps 2 and 3**.
2. Cells should be released from the flasks by scraping and then pipetted into a 15- or 50-mL conical screw-cap centrifuge tube. The flasks should be rinsed with 5–10 mL additional ice-cold 10% TCA, and this suspension should also be pipetted into the centrifuge tube.

3. The tubes containing the cells suspended in 10% TCA fixing solution should be centrifuged at 20,000g for 5 min.
4. The supernatant in the centrifuge tubes should be removed and discarded.
5. Add 5.0 mL of 5% TCA containing 1 mM EDTA to each tube and gently resuspend the pellets.
6. Centrifuge as in **step 4** and remove the supernatants. Decant the solution and keep tubes containing the pellets on ice or store the tubes at -80°C .

3.3. Lipid Extraction (see Note 1)

1. A cell pellet should be resuspended in 0.75 mL chloroform/methanol/conc. HCl (40:80:1; prepared fresh prior to use). The tube containing cells should be kept on ice for 20 min except for times when tubes are vortexed vigorously (every 60 s for 15 s each time).
2. Add 0.25 mL chloroform and 0.45 mL of 0.1 M HCl and vortex vigorously for 1 min.
3. Centrifuge the tube at 17,500g for 2 min.
4. Carefully remove the aqueous layer (top) to another tube. Phosphoinositides are found in the organic layer (bottom), and should be retrieved carefully by gently pushing a pipet or pipet tip through the interphase and accessing the organic layer.
5. Place the organic phase in a separate tube and add 50 μL of 1 M ammonia.
6. To the aqueous layer from **step 4**, add 0.5 mL of the chloroform/methanol/HCl. Vortex the tube and centrifuge as in **step 3**.
7. Combine the organic phase from **step 6** and with the organic phase from **step 5**. The aqueous phase can be discarded or saved. The aqueous phase contains inositol phosphates (e.g. 1,4,5-trisphosphate) that can be analyzed using strong anion-exchange HPLC.
8. Dry the organic phase from the extractions using a SpeedVac concentrator or under nitrogen.
9. Samples can be stored at -80°C or deacylated by the procedure in **Subheading 3.4**.

3.4. Deacylation of Phosphoinositides

The lipid chains of the phosphoinositides must be released prior to the analysis of the glycerophosphoinositol head groups by HPLC. If samples are small, the following steps can be done in high-quality 1.5-mL polypropylene snap-cap centrifuge tubes. If the samples are larger, high-quality polypropylene conical 15-mL centrifuge tubes should be used.

1. Resuspend the dried pellet obtained from the lipid extraction by adding 0.5 ml of methylamine reagent (methylamine : methanol : *n*-butanol : dH_2O , 26.8% : 45.7% : 11.4% : 16.1%; made fresh before use) to the tube and sonicate the tube in a bath sonicator.

2. Incubate tube at 53°C in a block heater for 50 min. If 1.5-mL microcentrifuge tubes are used, the caps need to be screw-on type or they need to be locked down with cap locks.
3. Remove the tube from the block heater and then allow it to cool down to room temperature and centrifuge briefly so the sample is at the bottom of the tube, then dry the sample in a SpeedVac or under nitrogen.
4. Sample can be stored at -80°C or be extracted as described in **Subheading 3.5**.

3.5. Extraction of Glycerophosphoinositols

1. To the deacylated sample (in a high-quality 1.5- or 2.0-mL polypropylene tube), add 0.75 mL of sterile ddH₂O. Sonicate the tube in the bath sonicator to resuspend the pellet.
2. Add 0.5 mL of *n*-butanol : petroleum ether : ethyl formate (20 : 4 : 1; prepared fresh prior to use).
3. Vortex the tube vigorously for 1 min.
4. Centrifuge the tube at 10,000g for 3 min.
5. Transfer the bottom (aqueous) phase to a new tube and add 0.5 mL of *n*-butanol : petroleum ether : ethyl formate. Repeat **steps 3–5** so that the sample is extracted a total of three times.
6. Transfer the aqueous sample to a new tube and dry it in a SpeedVac or under nitrogen. Prior to HPLC analysis, resuspend the sample from **step 6** containing glycerophosphoinositols in 200 μL of ddH₂O and count 10 μL in a liquid scintillation counter. A typical sample will have greater than 5×10^6 cpm (counts per minute).

3.6. HPLC Analysis of Glycerophosphoinositols (see Note 2)

The deacylated lipids are resolved using anion-exchange chromatography with a Whatman Partisil 5 SAX (4.6 × 250 mm) or Partisil 10 SAX (4.6 × 250 mm) column fitted with a guard column (Phenomenex, Torrance, CA). A Beckman System Gold chromatograph equipped with a UV detector and Beckman System Gold software or equivalent system should be used. All samples should be spiked with internal controls of AMP, ADP, and ATP in order to monitor the column performance. Typically, a portion of each sample to be loaded on the column (5×10^6 cpm or more) can be mixed with 40 nmol each of AMP, ADP, ATP and applied to the column. For reference, glycerophosphoinositol phosphate species [gPI(3)P and gPI(4)P] elute between AMP and ADP, glycerophosphoinositol bisphosphate species [gPI(3,4)P₂ and gPI(3,5)P₂] and gPI(4,5)P₂] elute between ADP and ATP, and gPI(3,4,5)P₃ elutes just after ATP. Phosphoinositides can be resolved on the anion-exchange column with the following mobile phase: 5 mL of isocratic 10 mM ammonium phosphate (pH 3.8), 60 mL of a linear gradient (10–800 mM), a 10-mL gradient from 800 mM to 1000 mM, then 10 mL of 1000 mM of ammonium phosphate (pH 3.8) at a flow rate of 1 mL/min. Fractions should be collected every 20 s, mixed with 2–3 mL EcoLume (ICN), and counted in a liquid scintillation counter (Beckman LS 5801) (*see Note 3*).

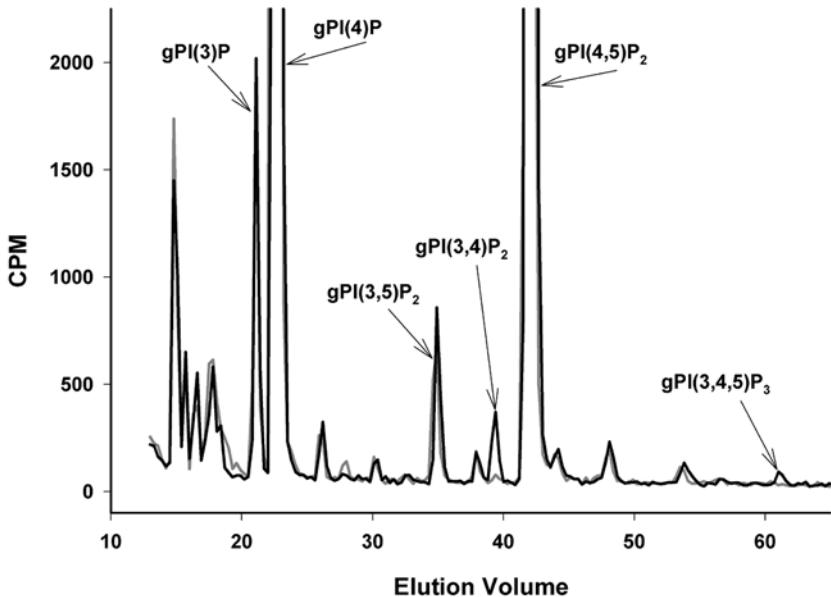

Fig. 2. HPLC analysis of glycerophosphoinositols from PDGF-stimulated 3T3-L1 cells. 5×10^6 cpm of sample was injected onto a Partisil 10 SAX column and samples resolved using gradient described in the text. Fractions were collected and counted in a scintillation counter and counts in each fraction were plotted. gPI(3)P is glycerophosphoinositol 3-phosphate, gPI(4)P is glycerophosphoinositol 4-phosphate, and the other glycerophosphoinositol species are likewise designated.

Figure 2 illustrates a radioactivity profile generated from 3T3-L1 preadipocytes stimulated with PDGF. The profile displays all of the glycerophosphoinositols except gPI(5)P and provides a relative measure of the levels of phosphoinositides when compared to those from unstimulated cells. In addition, this profile illustrates the consistent order of elution of the phosphoinositides [gPI(5)P elutes just after gPI(4)P].

3.7. Preparation of Phosphoinositide Standards

Standards are necessary to calibrate the column for a specific ammonium phosphate gradient; precise coelution of glycerophosphoinositols from a sample with simultaneously or previously chromatographed standard is the accepted approach for identification of particular phosphoinositides. There are three ways commonly used to obtain standards: (1) purchase commercially available radio-labeled standards [PtdIns(4,5) P_2 is available from Amerisham or Perken Elmer]; (2) synthesize standards using *in vitro* reactions, perform TLC, elute the standard from the TLC plate, deacylate the phosphoinositide, and chromatograph it on the

HPLC; or (3) radiolabel cells (e.g., *Saccharomyces cerevisiae*) that have a well-defined pattern of phosphoinositides and chromatograph the glycerophosphoinositols from these cells.

Utilizing both mammalian cell and yeast cell extracts, all phosphoinositide standards except PtdIns(5)P can be generated without significant difficulty. Wild-type *S. cerevisiae* cells have abundant PtdIns 3-kinase and PtdIns 4-kinase activities that can be used to produce [32 P]glycerophosphoinositol 3-phosphate [gPI(3)P] and [32 P]glycerophosphoinositol 4-phosphate [gPI(4)P] standards using an in vitro containing phosphatidylinositol and γ -[32 P]ATP. Yeast extracts can be prepared from strain W303C. Similarly, mammalian cell extracts can be prepared for in vitro reactions that will yield PtdIns(3,4)P₂ and PtdIns(3,4,5)P₃. The most effective extracts are from cells that overexpress the p110 PI3-kinase (type I). For example, NIH3T3 fibroblasts cells transfected with a p110 PI3-kinase expression vector can be extracted and substrates provided [PtdIns(4)P or PtdIns(4,5)P₂] for in vitro reactions that will yield PtdIns(3,4)P₂ and PtdIns(3,4,5)P₃. The products of these reactions should be resolved on TLC plates with simultaneous chromatography of unlabeled standards available commercially (Echelon Biosciences).

3.8. In Vitro Phosphatidylinositol Kinase Reactions

Phosphatidylinositol/phosphoinositide kinase reactions can be performed in vitro as previously described (7,9,10). Phosphatidylinositol or phosphoinositides can be supplied as substrate together with γ -[32 P]ATP. Products of the in vitro reactions should be resolved using TLC and detected with autoradiography. The migration of the radiolabeled species can be compared to unlabeled standards that are commercially available (Echelon Biosciences). The unlabeled standards can be detected by placing iodine crystals that produce iodine vapors in a closed container with the TLC plate. Comigration of the unlabeled standard and radiolabeled phosphoinositide should be determined and the radiolabeled phosphoinositide “spot” on the plate can be carefully scraped and placed in a tube for subsequent elution with chloroform and deacylation by the procedure described above.

3.9. TLC of Labeled Phosphoinositides

Several procedures have been developed for the separation and detection of phosphoinositides via TLC. Total labeled cellular phospholipids ([32 P]-labeled) can be spotted onto a silica gel 60 plate (0.25 mm thick) and developed with chloroform/methanol/4.2 N ammonium hydroxide (9 : 7 : 2). Separation of PtdIns(3)P, PtdIns(4)P, and PtdIns(5)P can be accomplished by published procedures (9,11). Separation of mono-, bis-, and tris-phosphorylated phosphoinositides can be accomplished on silica gel 60 plates developed with a 65 : 35 (v/v) *n*-propanol : 2 M acetic acid solvent (7).

Finally, an effective way to corroborate the identity of phosphoinositide standards is to generate cell-specific maps of phosphoinositide HPLC profiles. Phosphoinositide HPLC profiles have been published for yeast, mammalian, and plant cells (**10,12**). Yeast is useful because PtdIns(3)P, PtdIns(4)P, and PtdIns(4,5)P₂ are abundant in dividing cells and PtdIns(3,5)P₂ is found at low concentrations. In salt-stressed yeast [1 M NaCl for 20 min (**10**)], PtdIns(3,5)P₂ rapidly accumulates to levels approximately the same as PtdIns(4,5)P₂. In 3T3-L1 adipocytes, PtdIns(3)P is found at relatively low levels and PtdIns(4)P and PtdIns(4,5)P₂ are relatively abundant. PtdIns(3,4)P₂ and PtdIns(3,4,5)P₃ are detectable at very low levels in cells not stimulated with growth factors (e.g., PDGF and insulin). After stimulation of 3T3-L1 preadipocytes or adipocytes with PDGF, PtdIns(3,4)P₂ and PtdIns(3,4,5)P₃ rapidly accumulate to levels several-fold higher than in unstimulated cells. Insulin stimulation of 3T3-L1 preadipocyte and adipocyte cells leads primarily to an increase in PtdIns(3,4,5)P₃.

4. Notes

1. An alternative to extraction of lipids with chloroform : methanol : HCl is to extract with a solvent composed of 95% ethanol: diethyl ether:pyridine (EEP; 15:5:1 v/v/v). This solvent is more efficient for extraction of all the phosphoinositides, but phase separation is not used, so inositol phosphates are not partitioned into an aqueous phase away from the phosphoinositides in the organic phase of chloroform : methanol : HCl extractions. For the EEP extraction, sample is vortexed as described and then incubated at 57°C for 30 min, centrifuged to clear unwanted particulate, and the supernatant is dried in the SpeedVac prior to deacylation.
2. A nonradioactive detection method for phosphoinositides has recently been developed (**13**). The apparent resolution of this procedure is not as high as the radioisotope procedure described, but this method will undoubtedly have utility for some applications.
3. Radioactivity of the eluant can be measured continuously using in-line radioactivity detectors like a Beta-RAM in-line detector (INUS Systems, Tampa, FL).

References

1. Nave, B. T., Siddle, K., and Shepherd, P. R. (1996) Phorbol esters stimulate phosphatidylinositol 3,4,5-trisphosphate production in 3T3-L1 adipocytes: implications for stimulation of glucose transport. *Biochem. J.* **318**(Pt. 1), 203–205.
2. Nave, B. T., Haigh, R. J., Hayward, A. C., Siddle, K., and Shepherd, P. R. (1996) Compartment-specific regulation of phosphoinositide 3-kinase by platelet-derived growth factor and insulin in 3T3-L1 adipocytes. *Biochem. J.* **318**(Pt. 1), 55–60.
3. Modan-Moses, D., Janicot, M., McLenithan, J. C., Lane, M. D., and Casella, S. J. (1998) Expression and function of insulin/insulin-like growth factor I hybrid receptors during differentiation of 3T3-L1 preadipocytes. *Biochem. J.* **333**(Pt. 3), 825–831.

4. Funaki, M., Katagiri, H., Kanda, A., Anai, M., Nawano, M., Ogihara, T., et al. (1999) p85/p110-Type phosphatidylinositol kinase phosphorylates not only the D-3, but also the D-4 position of the inositol ring. *J. Biol. Chem.* **274**(31), 22019–22024.
5. Sbrissa, D., Ikononov, O. C., and Shisheva, A. (1999) PIKfyve, a mammalian ortholog of yeast Fab1p lipid kinase, synthesizes 5-phosphoinositides. Effect of insulin. *J. Biol. Chem.* **274**(31), 21589–21597.
6. Gagnon, A., Dods, P., Roustan-Delatour, N., Chen, C. S., and Sorisky, A. (2001) Phosphatidylinositol-3,4,5-trisphosphate is required for insulin-like growth factor 1-mediated survival of 3T3-L1 preadipocytes. *Endocrinology* **142**(1), 205–212.
7. Ko, K. W., Avramoglu, R. K., McLeod, R. S., Vukmirica, J., and Yao, Z. (2001) The insulin-stimulated cell surface presentation of low density lipoprotein receptor-related protein in 3T3-L1 adipocytes is sensitive to phosphatidylinositide 3-kinase inhibition. *Biochemistry* **40**(3), 752–759.
8. Sbrissa, D., Ikononov, O., and Shisheva, A. (2001) Selective insulin-induced activation of class I(A) phosphoinositide 3- kinase in PIKfyve immune complexes from 3T3-L1 adipocytes. *Mol. Cell. Endocrinol.* **181**(1–2), 35–46.
9. Stack, J. H. and Emr, S. D. (1994) Vps34p required for yeast vacuolar protein sorting is a multiple specificity kinase that exhibits both protein kinase and phosphatidylinositol-specific PI 3-kinase activities. *J. Biol. Chem.* **269**(50), 31,552–31,562.
10. Hama, H., Takemoto, J. Y., and DeWald, D. B. (2000) Analysis of phosphoinositides in protein trafficking. *Methods* **20**(4), 465–473.
11. Stack, J. H., DeWald, D. B., Takegawa, K., and Emr, S. D. (1995) Vesicle-mediated protein transport: regulatory interactions between the Vps15 protein kinase and the Vps34 PtdIns 3-kinase essential for protein sorting to the vacuole in yeast. *J. Cell. Biol.* **129**(2), 321–334.
12. Serunian, L.A., Auger, K.R., and Cantley, L.C. (1991) Identification and quantification of polyphosphoinositides produced in response to platelet-derived growth factor stimulation. *Methods Enzymol.* **198**, 78–87
13. Nasuhoglu, C., Feng, S., Mao, J., Yamamoto, M., Yin, H. L., Earnest, S., et al. (2002) Nonradioactive analysis of phosphatidylinositides and other anionic phospholipids by anion-exchange high-performance liquid chromatography with suppressed conductivity detection. *Anal. Biochem.* **301**(2), 243–254.

Measurement of Glycogen Synthesis and Glycogen Synthase Activity in 3T3-L1 Adipocytes

Matthew J. Brady

1. Introduction

Insulin stimulates the storage of glucose as glycogen in muscle and adipose tissue through the coordinate increase in glucose uptake and modulation of glycogen metabolizing enzymes (1). Insulin binds to its receptor in peripheral tissues and initiates several signaling cascades to increase glucose uptake via translocation of the glucose transporter-4 (GLUT-4) containing vesicles to the plasma membrane (see Fig. 1). Glucose enters the cells and is phosphorylated by hexokinases to form glucose-6-phosphate (G6P). Depending on the energy requirements of the cell, G6P can be used to generate ATP via glycolysis or be metabolized to uridine diphospho (UDP)-glucose and stored as glycogen. Measurement of glycogen synthesis rates in cells and tissues is thus a powerful way to examine several insulin metabolic responses simultaneously.

Glycogen synthase, the rate-limiting enzyme for glycogen synthesis, catalyzes the incorporation of UDP-glucose into glycogen chains. The enzyme is regulated by both covalent and allosteric mechanisms (2). Glycogen synthase is phosphorylated on multiple residues, resulting in its progressive inactivation. Insulin stimulates glycogen synthase activity by promoting its net dephosphorylation, through phosphatase activation and kinase inhibition. This action of insulin is facilitated by the stimulation of glucose uptake, because the resulting increase in G6P leads to the allosteric activation of glycogen synthase and increased susceptibility to dephosphorylation (3,4).

3T3-L1 adipocytes are a widely used cell line model for the study of insulin metabolic signaling. These cells are grown as fibroblasts, but they can be ter-

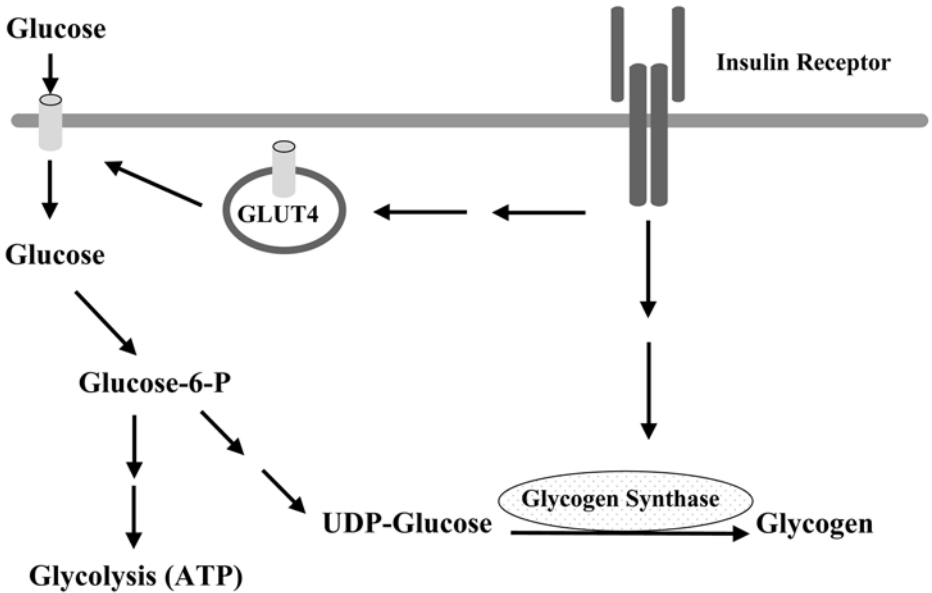

Fig. 1. Dual effect of insulin on glucose metabolism in peripheral tissues. In skeletal muscle and adipose tissues, binding of insulin to its receptor stimulates GLUT-4 vesicle translocation, increasing glucose uptake and intracellular levels of glucose-6-phosphate (G6P). G6P can be used to generate ATP or be metabolized to form uridine diphospho (UDP)-glucose. Insulin also promotes the dephosphorylation and activation of glycogen synthase, which incorporates UDP-glucose into glycogen chains.

minally differentiated into lipid-containing adipocytes. Although it may seem counterintuitive to study glycogen metabolism in adipocytes, these cells contain high levels of glucose transporters, insulin receptors, and glycogen synthase and are very metabolically active.

Glucose uptake and storage as glycogen is assayed by adding radioactive glucose as a tracer to the extracellular medium, followed by isolation of cellular glycogen. Glycogen synthase activity is assayed *in vitro* by measuring the incorporation of UDP-glucose into purified glycogen. These procedures have been adapted for use in 3T3-L1 adipocytes from earlier protocols (5–7).

2. Materials

2.1. Reagents

2.1.1. Glycogen Synthase Assay

1. Glycogen synthase buffer (GSB): 50 mM HEPES (pH 7.8), 10 mM EDTA, and 100 mM NaF.

2. Krebs Ringer buffer with 30 mM HEPES (pH 7.4) (KRBH): 136 mM NaCl, 30 mM HEPES (pH 7.4), 5 mM sodium phosphate (pH 7.4), 4.7 mM KCl, 1 mM MgSO₄, 1 mM CaCl.
3. UDP-glucose (Sigma cat. no. U4625).
4. ³H-UDP-glucose (60 Ci/mmol) (see **Note 1**).
5. Glucose-6-phosphate (Sigma cat. no. G7879).
6. Rat liver glycogen, type III (Sigma cat. no. G8876).
7. 70% Ethanol stocks, 4°C and room temperature (RT).
8. Whatman GF/A filters, 24 mm in diameter (cat. no. 1820–024).

2.1.2. Glycogen Synthesis Assay

1. Krebs Ringer buffer with 30 mM HEPES (pH 7.4) (KRBH).
2. ¹⁴C-Glucose (250 mCi/mmol).
3. Rat liver glycogen, type III (Sigma cat. no. G8876).
4. Potassium hydroxide pellets.
5. 95% Ethanol, room temperature.
6. 70% Ethanol, 4°C.

2.2. Equipment

2.2.1. Glycogen Synthase Assay

1. Rocking platform.
2. Container with lid to wash filters.
3. Aerosol resistant tips for P200 Pipetman.
4. Schleicher and Schuell membrane marking pen (cat. no. 02380) or ethanol-resistant marking pen.

2.2.2. Glycogen Synthesis Assay

1. 13 × 100 glass borosilicate test tubes.
2. Heating block (100°C) with proper blocks for test tubes.
3. Table-top centrifuge with proper holders for test tubes.
4. Aerosol resistant tips for P1000 Pipetman
5. Schleicher and Schuell membrane marking pen (cat. no. 02380), or ethanol-resistant marking pen.

3. Methods

For both assays, cells are used 4–10 d after completion of the 3T3-L1 adipocyte differentiation protocol (**8**), when >90% of the cells display the adipocyte phenotype.

3.1. Preparation of Lysates for Glycogen Synthase Assay

1. Use 3T3-L1 adipocytes cultured in six-well dishes. Wash the cells two times with PBS (37°C) and serum-starve for 3 h using 2 mL per well of KRBH/0.5% bovine serum albumin (BSA)/5 mM glucose (see **Note 2**).

2. Incubate the cells in the absence and presence of 100 nM insulin for 15 min in a 37°C CO₂ incubator.
3. Make up homogenization buffer: GSB + 0.5% Triton X-100 + desired protease inhibitors (i.e., 1 mM benzamidine and 0.1 mM phenylmethylsulfonyl fluoride [PMSF]).
4. Place dishes on ice and wash cells three times with ice-cold phosphate-buffered saline (PBS). Aspirate PBS completely and add 300 µL of homogenization buffer per well. Scrape cells with the back of a yellow Pipetman tip or cell scraper. When finished, leave six-well dish on ice, tilted at an angle to collect cells at the bottom of the wells.
5. Gently pipet cells three times with a P1000 and transfer to a 1.7-mL microfuge tube. Spin samples 10 min, 5000 rpm, 4°C in a microfuge.
6. Transfer supernatants to new tubes. Be careful not to disturb the pellet on the bottom of the tube.
7. Samples can be assayed immediately or snap-frozen in liquid nitrogen and stored at -20°C until needed.

3.2. Assay of Glycogen Synthase Activity

Glycogen synthase assays measure the rate of incorporation of UDP-glucose into glycogen, in the absence and presence of the allosteric activator G6P. The glycogen is precipitated onto glass filters with cold ethanol, free ³H-UDP-glucose is washed away, and ³H-incorporation into glycogen is measured by liquid scintillation counting. Reactions are usually performed in duplicate (two -G6P, two +G6P), but each condition can be done in triplicate especially when first learning the assay (*see Note 3*).

1. Calculate the number of reactions to be run (four to six lysate sample). Multiple reaction number by 50 µL to get the total volume of reaction mix needed. Round up by 200 µL for blanks and to ensure you do not run out. For each milliliter of reaction mix, add 16 mg of glycogen to 1 mL of GSB (without TritonX-100). Warm to 37°C for 5–10 min and vortex to dissolve glycogen.
2. Place GSB + glycogen on ice and add 60 µL/mL of 200 mM UDP-glucose. Add 2µCi/mL of ³H-UDP-glucose and vortex. Split the reaction mix equally into two tubes labeled “-” and “+.” Add 62.5 µL/500 µL of double-distilled water to the “-” tube. Add 62.5 µL/500 µL of 200 mM G6P to the “+” tube.
3. Reactions are performed in microfuge tubes in a final volume of 100 µL. Place the tubes on ice in racks that can be transferred to a water bath. Label tubes 1, 2, 3, and so on.
4. Add 50 µL (approx 100 µg) of each lysate to four reaction tubes (*see Note 4*). Sample 1 goes in tubes 1–4, sample 2 in 5–8, and so forth. Add 50 µL of “-” reaction mix to the odd-numbered tubes and 50 µL of “+” reaction mix to the even-numbered tubes. Label two tubes “blank” and add 50 µL of GSB + 50 µL of reaction mix.

5. Seal tubes and vortex gently. If there are droplets on the sides of the tubes, spin tubes 3 s in a microfuge.
6. Transfer racks to a 37°C water bath for 15 min. Then, place racks in an ice-water bath for 15 min.
7. Label GF/A filters on a piece of aluminum foil using a Schleicher and Schuell marking pen. *Do not* use regular Sharpies.
8. Pick up the filter with a tweezer and spot 90 μL of reaction onto it. Use aerosol resistant tips and move Pipetman around filter while spotting. Wait 3 s and drop filter into a container on ice with approximately 200 mL of 70% ethanol (4°C).
9. When finished spotting filters, gently wash for 15 min at 4°C. You can either shake in a cold room or keep box on ice and use a room temperature shaker. It is very important to shake the filters gently, as they can disintegrate if agitated too hard. Wash two more times for 15 min in 70% ethanol at room temperature.
10. Remove filters and place on a paper towel in fume hood for 30–60 min to dry. Alternatively, place filters flat in 20-mL scintillation vials and air-dry overnight.
11. Add 5 mL of scintillation fluid to filters in 20-mL scintillation vials and count 1–5 min in a liquid scintillation counter. Average the cpms and divide $-G6P$ counts (active glycogen synthase) by $+G6P$ counts (total glycogen synthase) to get activity ratio.

3.3. Assay of Glycogen Synthesis Rate

Insulin-stimulated glycogen synthesis in 3T3-L1 adipocytes is dependent on increased glucose uptake and glycogen synthase activity. The cells are pre-treated with insulin to activate both processes before the addition of ^{14}C -labeled glucose to the extracellular media. The cells are washed and lysed, and cellular glycogen is precipitated with ethanol. Glycogen pellets are washed and dried overnight, and ^{14}C -glucose incorporation into glycogen is measured by liquid scintillation counting.

1. Use 3T3-L1 adipocytes cultured in six-well dishes (*see Note 5*). Wash the cells two times with PBS (37°C) and serum-starve for 3 h using 2 mL per well of KRBH/0.5% BSA/5 mM glucose (*see Note 2*).
2. ^{14}C -Glucose stock is made up in KRBH/0.5% BSA/5 mM glucose at a final concentration of 1 $\mu\text{Ci}/50 \mu\text{L}$. Calculate amount of isotope needed (1 μCi per well), transfer to a plastic test tube, and dry off ethanol under an airstream. Add appropriate amount of media and place stock at 37°C until needed.
3. Make 30% KOH on day of use and warm 30% KOH + 6 mg/mL glycogen stock at 37°C until glycogen dissolves (5–10 min) (*see Note 6*). Leave both at room temperature. Label 13×100 test tubes with an ethanol-resistant marker.
4. Stimulate cells in the absence and presence of 100 nM insulin for 15 min. Then, add 50 μL (1 μCi) of the ^{14}C -glucose solution to all wells. Mix gently and place in a 37°C CO_2 incubator.

5. After 30 min, place cells on ice and wash three times with PBS (4°C). Aspirate completely and add 1 mL of 30% KOH per well. Scrape the cells using the back of a yellow Pipetman tip or cell scraper.
6. Transfer cells to 13 × 100 test tubes using a P1000 Pipetman and aerosol-resistant tips. Add 1 mL of 30% KOH to each of two “blank” tubes. Add 200 μL of 30% KOH + 6 mg/mL glycogen to all tubes. Vortex gently and place in 100°C heating block. After 15 min, turn heat down to 85°C.
7. After a further 15 min, transfer tubes into racks and add 2.5 mL of 95% ethanol to all tubes. Vortex gently but thoroughly until the samples are uniformly cloudy (*see Note 7*). Return to 85°C heating block for 30 min.
8. Transfer tubes to racks in an ice-water bath. Let chill for 15 min to completely precipitate the glycogen. Spin samples 10 min, 3500 rpm at 4°C in a table-top centrifuge.
9. Aspirate ethanol supernatant, but leave 100 μL to avoid disturbing the pellets. Add 3 mL of 70% ethanol (4°C) and centrifuge samples for 5 min as described in **step 8**. Repeat once more.
10. Remove as much ethanol as possible without touching the bottom of the test tube. Let samples dry overnight on a benchtop (*see Note 8*). On the next day, add 1 mL of deionized water, vortex well, and heat samples at 37°C for at least 30 min. Vortex occasionally to help dissolve the glycogen.
11. Transfer samples to 20-mL scintillation vials using a P1000 Pipetman and aerosol-resistant tips. Add 9 mL of scintillation fluid, shake well, and count each sample for 2 min in a liquid scintillation counter (*see Note 9*).

4. Notes

1. ¹⁴C-UDP-glucose can be used in the assay at 1 μCi/mL of reaction mix. However, ³H-UDP-glucose is substantially less expensive.
2. Dulbeccos’s modified Eagle’s medium (DMEM)/0.5% fetal bovine serum (FBS) can be used in place of the KRBH/0.5% BSA; however, make sure to use low glucose (5 mM DMEM).
3. Glycogen synthase activation can also be detected as a downward mobility shift on sodium dodecyl sulfate–polyacrylamide gel electrophoresis (SDS-PAGE) gels. Extra lysate can be immunoblotted using anti-GS antisera (Chemicon, cat. no. MAB3106).
4. 3T3-L1 adipocytes have high levels of glycogen synthase, making detection of basal and insulin-stimulated activities relatively easy. When attempting this assay with other cell lines, significantly more lysate protein may have to be included.
5. 3T3-L1 adipocytes plated in 12-well dishes can also be used. The only modification is that at **step 5**, scrape the wells in 0.5 mL of 30% KOH, transfer to test tubes containing 0.5 mL of 30% KOH, and then continue the protocol.
6. Do not use NaOH pellets instead of KOH; it will not work.
7. The samples should turn cloudy when the ethanol is added to precipitated glycogen. If they do not, either the ethanol is the wrong concentration or the 200 μL of 6 mg/mL glycogen was not added. If the latter has occurred, stop adding the ethanol.

Add the 6-mg/mL glycogen solution to the samples, heat for 15 min at 85°C, and then continue the protocol by addition of 95% ethanol.

8. After drying the precipitated samples overnight, there is sometimes a visible cloudy pellet, sometimes a clear bumpy pellet. Occasionally, you will have a combination of the two among your samples. Do not be concerned, as there is no correlation between counts precipitated and the pellet phenotype.
9. This protocol has been adapted to measure glucose incorporation into both glycogen and lipid from the same well (9).

5. References

1. Brady, M. J., Pessin, J. E., and Saltiel, A. R. (1999) Spatial compartmentalization in the regulation of glucose metabolism by insulin. *Trends Endocrin. Metabol.* **10**, 408–413.
2. Lawrence, J. C., Jr. and Roach, P. J. (1997) New insights into the role and mechanism of glycogen synthase activation by insulin. *Diabetes* **46**, 541–547.
3. Lawrence, J. C., Jr. and James, C. (1984) Activation of glycogen synthase by insulin in rat adipocytes. Evidence of hormonal stimulation of multisite dephosphorylation by glucose transport-dependent and -independent pathways. *J. Biol. Chem.* **259**, 7975–7982.
4. Cadefau, J., Bollen, M., and Stalmans, W. (1997) Glucose-induced glycogenesis in the liver involves the glucose-6-phosphate-dependent dephosphorylation of glycogen synthase. *Biochem. J.* **322**, 745–750.
5. Hess, S. L., Suchin, C. R., and Saltiel, A. R. (1991) The specific protein phosphatase inhibitor okadaic acid differentially modulates insulin action. *J. Cell Biochem.* **45**, 374–380.
6. Thomas, J. A., Schlender, K. K., and Lerner, J. (1968) A rapid filter paper assay for UDPglucose–glycogen glucosyltransferase, including an improved biosynthesis of UDP-14C-glucose. *Anal. Biochem.* **25**, 486–499.
7. Lazar, D. F., Wiese, R. J., Brady, M. J., Mastick, C. C., Waters, S. B., Yamauchi, K., et al. (1995) Mitogen-activated protein kinase inhibition does not block the stimulation of glucose utilization by insulin. *J. Biol. Chem.* **270**, 20,801–20,807.
8. Brady, M. J., Kartha, P. M., Aysola, A. A., and Saltiel, A. R. (1999) The role of glucose metabolites in the activation and translocation of glycogen synthase by insulin in 3T3-L1 adipocytes. *J. Biol. Chem.* **274**, 27,497–27,504.
9. Jensen, T. C., Crosson, S. M., Kartha, P. M., and Brady, M. J. (2000) Specific desensitization of glycogen synthase activation by insulin in 3T3-L1 adipocytes. *J. Biol. Chem.* **275**, 40,148–40,154.

FOR REFERENCE PURPOSES ONLY

Measurement of Contraction-Stimulated GLUT-4 Translocation in Isolated Skeletal Muscle

Joseph T. Brozinick, Jr.

1. Introduction

The ability of cells to transport glucose through the plasma membrane and into the cell for use in metabolism is of prime importance in cellular metabolism. This process occurs through a family of glucose transport proteins (**1**). In insulin-sensitive cells, such as heart, skeletal muscle, and adipose tissue, glucose transport is mediated by two members of this family, termed GLUT-1 and GLUT-4. Of these two transporters, GLUT-1 is found primarily in the plasma membrane and functions in regulation of basal glucose transport. However, in the basal non-stimulated state, GLUT-4 is found primarily in an intracellular storage site, and in response to insulin GLUT-4-containing vesicles, they translocate to the plasma membrane, where they dock, fuse, and allow the exposed GLUT-4 transporters to transport glucose (**2**). In fact, a major feature of type 2 diabetes mellitus (NIDDM) is a defect in insulin-stimulated GLUT-4 translocation to the plasma membrane in skeletal muscle. Interestingly, in skeletal muscle, contractile activity possesses an insulin-like ability to stimulate GLUT-4 translocation, although it is unclear if the same population of GLUT-4 vesicles are recruited by both stimuli (**3**). Therefore, the ability to measure and quantify GLUT-4 translocation is of major importance in investigating this disease.

The majority of previous researchers who have investigated the effects of contractile activity on GLUT-4 translocation have used membrane fractionation and Western blotting with anti-GLUT-4 antibodies to quantify translocation (**3,4**). However, these preparations have intrinsic problems in that there is cross-contamination of membrane fractions that diminishes the degree of translocation

observed (5). Indeed, the majority of these studies have shown a twofold increase in GLUT-4 translocation to the plasma membrane, whereas the increase in glucose transport that is observed *in vivo* is usually 10- to 20-fold over basal (2,3,6).

Recently, a novel membrane impermeant reagent 2-*N*-(4-(1-azi-2,2,2-trifluoroethyl)benzoyl)-1,3-bis(D-mannose-4-yloxy)-2-propylamine (ATB-BMPA) has been described that can be used to covalently label surface glucose transporters. Recent publications have demonstrated that the increased glucose-transport rates observed in skeletal muscle correlates with increased cell surface GLUT-4, as assessed by labeling with this reagent (5,7). This procedure, therefore, gives the best estimate of contraction-stimulated GLUT-4 translocation and will be described in detail in this chapter. It should be noted that although this chapter describes using the isolated incubated muscle system to measure contraction-stimulated GLUT-4 translocation, the described photolabeling procedure can be used on muscle contracted *in situ* or from acutely exercised animals.

2. Materials

2.1. Reagents

1. Krebs–Henseleit buffer (KHB) stock solutions: Add 50 mL of stock 1 to 400 mL distilled H₂O and gas with 95%O₂, 5% CO₂ for 1 h. Add 50 mL of stock 2 and bring to 500 mL with distilled H₂O.
 - a. Stock 1 (10X): 1.16 M NaCl, 0.046 M KCl, 0.0116 M KH₂PO₄, and 0.0253 M NaHCO₃.
 - b. Stock 2 (10X): 0.025 M CaCl₂, 0.0116 M MgSO₄.
2. ICN Cohn Fraction V, fatty-acid-free bovine serum albumin (BSA) is used in all incubations directly without dialyzing.
3. ³H-2-*N*-(4-(1-azi-2,2,2-trifluoroethyl)benzoyl)-1,3-bis(D-mannose-4-yloxy)-2-propylamine (ATB-BMPA) from Toronto Research Chemicals. Stock is 5 mCi/mL; dry down under vacuum and resuspend at 10 mCi/mL in distilled H₂O; store at -20°C.
4. Homogenization buffer: 25 mM HEPES (pH 7.5), with 1 mM EDTA. Add fresh prior to use (final concentrations): benzamidine (1 mg/mL final), leupeptin (0.1 µg/mL), aprotinin (0.5 µg/mL), pepstatin (0.3 µg/mL), and AEBSF (Roche) (1 mM).
5. Thesit solubilization solution: 1 mM EDTA, 4% Thesit (Roche Biochemicals, Indianapolis, IN) in phosphate-buffered saline (PBS) (pH 7.4). Add fresh (final concentrations): *N*-ethylmaleimide (NEM), 0.5 mg/mL; leupeptin, 0.2 µg/mL; aprotinin, 1µg/mL; pepstatin, 0.7 µg/mL; and AEBSF, 2 mM. Solution is light sensitive; store wrapped in aluminum foil at 4°C.
6. 10X PBS: 100 mM NaH₂PO₄ (pH 7.4), 1.5 M NaCl.
7. The protein concentration is determined using the bicinchoninic protein assay kit (BCA kit, Pierce, Rockford, Ill)
8. Anti-GLUT-4 antibody. There are several GLUT-4 antibodies commercially available (Upstate Biotechnology, Lake Placid, NY or Santa Cruz Biotechnology, Santa Cruz, CA, among others). These should be tested for their ability to quantitatively

immunoprecipitated (IP) GLUT-4 from a sample solubilized by the described procedure prior to use in these experiments.

9. Protein-A–Agarose slurry (Invitrogen Corporation, Carlsbad, CA).
10. 2X Sodium dodecyl sulfate (SDS)–urea sample buffer: 0.5 M Tris-HCl (pH 6.8), 10% SDS, 4.6 M urea.
11. Bromphenol blue, 0.05 mg/mL. Add 30.84 mg/mL dithiothreitol (DTT) immediately prior to use (200 mM final).
12. Rainbow molecular-weight markers (Amersham, Piscataway, NJ).
13. Gel-solubilization solution: 98% H₂O₂ (30% stock) and 2% NH₄OH.
14. Cryotubes (Corning, Corning, NY).
15. 0.45 μm Ultrafree Spin Filters (Millipore).

2.2. Equipment

1. Ultraviolet (UV) crosslinking of ATB-BMPA to transporters is performed in a Rayonet UV oven RPR-100 (Southern New England Ultraviolet Company, Branford, CT).
2. Tissue preparations are centrifuged in a Beckman (Palo Alto, CA) TL-100 Table-top ultracentrifuge using a TL-100.4 rotor.
3. Tissues were homogenized using a Polytron-type homogenizer (Brinkman Instruments, Westbury, NY).
4. All SDS–polyacrylamide gel electrophoresis (SDS-PAGE) are performed with a Bio-Rad Protean II slab gel apparatus. Muscles are stimulated to contract in a specially designed apparatus (described in **Subheading 3**) that is mounted in a Grass Instruments tissue bath system (Grass Instruments, Boston, MA) and are stimulated with a Grass Instruments Square Wave Pulse Generator S-48.
5. Incubations are carried out in a shaking Dubnoff-type water bath with 25-mL Erlenmeyer flask holders.

3. Methods

3.1. Incubation of Isolated Muscles

1. Epitrochlearis muscles are removed under anesthesia from rats weighing approx 100 g (**5,8**). These muscles are ideally suited for incubation because they are thin and flat and give good glucose-transport responses to contraction (**9**). Alternatively, soleus muscles can be used for these experiments; however, these muscles do not respond as well to contractions and must be split prior to use in incubations, due to their thickness (**8,10**).
2. The excised muscles are rinsed in 0.9% saline and placed in 2 mL of preincubation media (KHB supplemented with 0.1% BSA, 32 mM mannitol, and 8 mM D-glucose) in 25-mL Erlenmeyer flasks in a 30°C water bath. The flasks are continuously gassed with 95% O₂/5% CO₂ and shaken at 1 cycle/s for 1 h.
3. Muscles are next transferred to the stimulation apparatus containing incubation media (2 mL; same as preincubation solution) as outlined in **Subheading 3.2**.



Fig. 1. Stimulators used for muscle stimulation. Body of device is made from Delrin plastic and is designed to fit into a Falcon 2059 (17 × 100) tube. Tube at top extends to bottom of device to allow gassing of media. Phono plug-type connector on top of device is attached to wires that run down the back of device and are attached to platinum wires with screws at right. Muscles are pinned to rubber pads at right and lie in between electrodes.

3.2. Stimulation of Muscle Contraction

1. Each muscle pair (one pair per rat) is pinned at resting length through the tendons at each end to a specially designed stimulation apparatus (see Fig. 1), which is designed so that the muscle lies in between two platinum electrodes. When mounted on the stimulation apparatus, the muscles are then immersed in 3 mL of incubation media (KHB supplemented with 0.1% BSA, 8 mM glucose, and 32 mM mannitol), in a Falcon 2059 tube that is continuously gassed with 95% O₂/5% CO₂ and maintained at 30°C. For each pair of muscles, one muscle will be contracted, and the other will serve as a resting control (see Note 1).
2. Numerous protocols exist for in vitro stimulation of rat skeletal muscle (8,11). We have found that the protocol described by Ryder et al. (11) gives the best fold stimulation of glucose transport for isolated muscles. In this protocol, muscles are stimulated with a Grass S48 Square Wave Stimulator at a frequency of 100 Hz (pulse duration of 0.2 ms, amplitude of 10 V) delivered at a rate of one 0.2-ms contraction every 2 s for 20 min (11). The muscle should be inspected during stimulation to insure that it is visibly contracting.
3. At the end of the stimulation period, remove the muscle from the stimulation apparatus and place it and the paired basal muscle in separate 25-mL Erlenmeyer flasks containing wash media (KHB supplemented with 40 mM mannitol and 2 mM pyruvate) for 10 min at 30°C. The muscles are then photolabeled as outlined in Subheading 3.3.

3.3. Photolabeling of Muscles

1. Incubate muscle for 4 min in 500 μL of ATB-BMPA media (prepared by diluting a 10-mCi/mL stock of ATB-BMPA 1 : 10 in KHB supplemented with 0.1% BSA). The ATB-BMPA is light sensitive and should be protected from direct light exposure. The incubation is performed in a 10-mL Erlenmeyer flask that is continuously gassed with 95% O₂/5% CO₂ at room temperature with continuous shaking.

2. Remove the muscle from the label media and place in the Rayonet UV lamp for 4 min, manually turning the muscles over at 2 min. The muscles can be placed on a watch glass or Petri dish for irradiation.
3. Trim tendons from muscles and freeze-clamp muscle between tongs cooled to the temperature of liquid nitrogen. Muscles can be stored in cryotubes or other freezer tubes at -80°C until processing.

3.4. Crude Membrane Preparation for GLUT-4 Immunoprecipitation

1. Weigh frozen muscle and place in a 13×51 -mm polycarbonate ultracentrifuge tube.
2. Add 1 mL of homogenization buffer and homogenize with a Polytron-type homogenizer for 30 s at maximum speed. Add an additional 1 mL of homogenization buffer during the last 15 s of homogenization. Centrifuge at 227,000g for 35 min in a TL-100.4 rotor.
3. Discard supernatant and add 500 μL of homogenization buffer. Scrape the pellet off the side of the tube with a spatula and homogenize again for 15 s at maximum. Add 0.5 mL of 4% Thesit and incubate at room temperature for 1 h. Centrifuge at 150,000g for 15 min in TL-100.4 rotor. The supernatant should contain total crude membranes.
4. Determine protein concentration in the supernatant using the Bicinchonic protein assay kit and use the remaining supernatant for immunoprecipitation of photolabeled GLUT-4.

3.5. Immunoprecipitation of GLUT-4

1. Start anti-GLUT-4 coupling to protein-A-agarose slurry (PAA) by adding 100 μL of PAA and 1 mL of PBS to a 1.5-mL microfuge tube.
 - a. Spin at 6000g for 1 min and remove supernatant; add 1 mL of PBS and repeat.
 - b. Add GLUT-4 antibody and 0.5 mL of PBS to PAA.
 - c. Incubate on rotator at 4°C for 2 h to overnight.Note that the amount of GLUT-4 antibody to be used will depend on the antibody and needs to be determined empirically. After incubation, spin complex at 6,000g for 1 min. Remove supernatant and wash two times with 1 mL of 1X PBS. The complex is now ready for use.
2. Add the solubilized samples to the GLUT-4 immune complex. Incubate overnight on rotator at 4°C . Spin samples at 6000g for 1 min to pellet the immune complex and then wash the pellet three times with 0.2% Thesit (prepared by diluting 4% Thesit solution 20-fold with PBS) and three times with 1X PBS.
3. Lyse sample from the immune complex by adding 100 μL of 2X SDS-urea sample buffer (*see Note 2*). Shake samples for 45 min at room temperature and 15 min at 55°C . Transfer samples to 0.45- μm Ultrafree Spin Filters (Millipore) and spin samples for 2 min at 14,000g. Flow through contains photolabeled samples, which are loaded on a SDS-PAGE gel in **step 4**.

4. Add 5–6 μL of Rainbow molecular-weight markers to each sample and load the sample on a 1.5-mm, 10-well $20 \times 20\text{-cm}$ 10% acrylamide SDS-PAGE gel, run overnight at 0.05 mA constant current (see **Note 3**).

3.6. Gel Slice Solubilization Procedure

1. Use Rainbow markers to determine lanes containing samples, slice the gel into 8-mm slices immediately after running, and place slices in 7-mL scintillation vials. When placing the slices in vials, make note of the slice numbers that contain the various molecular-weight markers. Dry the slices at 80°C for 3 h, cool to room temperature, and add 750 μL of gel-solubilization solution. Cap the vials and incubate at 80°C for 3 h to overnight.
2. Cool the vials to room temperature and add 7.5 mL of Aquasol (or any scintillation fluid that tolerates aqueous samples), vortex well, and count in a liquid scintillation counter vials (see **Notes 4** and **5**). Labeled GLUT-4 protein is quantified by integrating the area under the ^3H peak corresponding to the 45-kDa molecular-weight marker and subtracting the average background radioactivity in the gel for other slices.

4. Notes

1. It should be noted that muscles can also be stimulated *in situ* via the innervating nerve or by acute exercise and then removed and placed in incubation for measurement of GLUT-4 translocation. In the first case, the muscle is stimulated by 200-ms trains of stimuli at a frequency of 70 Hz, with each impulse in a train being 0.1 ms. The trains are delivered one per second at 10–15 V for 2×10 min with a 1-min rest in between. For acute exercise, rats can run on a treadmill at 20 m/min for 1 h or swim for 3 h (**12**). Finally, as an alternative to contraction or exercise, incubated muscles can be gassed for 1 h with 95% $\text{N}_2/5\%$ CO_2 during the preincubation. This mimics the effects of contraction and serves as a suitable alternative if an apparatus for electrically stimulated contraction is not available (**4**).
2. If desired, the efficacy of the immunoprecipitation can be tested by running 5 μL of the eluted sample on a 10% SDS-PAGE mini gel. The samples can then be analyzed by Western blotting with anti-GLUT-4 antibodies.
3. As an alternative to running a large SDS-PAGE gel, the samples can be run on minigels (Bio-Rad Mini-Protean II) at 0.05 mA for 2–3 h. In this case, the amount of PAA that is used should be reduced to 50 μL and the amount of SDS-urea sample buffer should be reduced to 40 μL .
4. It is important that the gel slices be allowed to cool after solubilization. Addition of the scintillation fluid when the samples are still hot can contribute to high background counts.
5. An alternative procedure to baking the gel slices and solubilizing in H_2O_2 is to run the samples on an acrylamide gel using *N,N'*-diallyltartardiamide (DATD) as a crosslinker rather than bis-acrylamide. A solution of 30% acrylamide and 15% DATD is used in lieu of the standard acrylamide-bis solution traditionally used to prepare a 10% acrylamide gel. After the gel is cut into slices, they are placed into

scintillation vials, 400 μ L of 2% periodic acid is added, and the vials are shaken for 1 h at room temperature. Scintillation fluid is then added and the samples are counted and quantified as for the regular procedure.

References

1. Gould, G. W. and Holman, G. D. (1993). The glucose transporter family: structure, function and tissue-specific expression. *Biochem. J.* **295**, 329–341.
2. Cushman, S. W. and Wardzala, L. J. (1980). Potential mechanism of insulin action on glucose transport in the isolated rat adipose cell: apparent translocation of intracellular transport systems to the plasma membrane. *J. Biol. Chem.* **255**(10), 4758–4762.
3. Goodyear, L. J., King, P. A., Hirshman, M. F., Thompson, C. M., Horton, E. D., and Horton, E. S. (1990). Contractile activity increases plasma membrane glucose transporters in absence of insulin. *Am. J. Physiol.* **258**, E667–E672.
4. Cartee, G. D., Douen, A. G., Ramlal, T., Klip, A., and Holloszy, J. O. (1991). Stimulation of glucose transport by hypoxia. *J. Appl. Physiol.* **70**, 1593–1600.
5. Brozinick, J. T., McCoid, S. C., Reynolds, T. H., Wilson, C. M., Stevenson, R. W., Cushman, S. W., et al. (1997). Regulation of cell surface GLUT-4 in skeletal muscle of transgenic mice. *Biochem. J.* **321**, 75–81.
6. Holloszy, J. O. and Hansen, P. A. (1996). Regulation of glucose transport into skeletal muscle. *Rev. Physiol. Biochem. Pharm.* **128**, 99–193.
7. Lund, S., Holman, G. D., Schmitz, O., and Pedersen, O. (1995). Contraction stimulates translocation of glucose transporter GLUT-4 in skeletal muscle through a mechanism distinct from that of insulin. *Proc. Natl. Acad. Sci. USA* **92**, 5817–5821.
8. Henriksen, E. J., Bourey, R. E., Rodnick, K. J., Koranyi, L., Permutt, M. A., and Holloszy, J. O. (1990). Glucose transporter protein content and glucose transport capacity in rat skeletal muscle. *Am. J. Physiol.* **259**, E593–E598.
9. Zetan, N., Wallberg-Henriksson, H., and Henriksson, J. (1988). The rat epitrochlearis muscle: metabolic characteristics. *Acta Physiol. Scand.* **134**, 155–156.
10. Henriksen, E. J. and Holloszy, J. O. (1991). Effect of diffusion distance on measurement of rat skeletal muscle transport *in vitro*. *Acta Physiol. Scand.* **143**, 381–386.
11. Ryder, J. W., Fahlman, R., Wallberg-Henriksson, H., Alessi, D., Krook, A., and Zierath, J. R. (2000). Effect of contraction on mitogen-activated protein kinase signal transduction in skeletal muscle. *J. Biol. Chem.* **275**, 1457–1462.
12. Slentz, C. A., Gulve, E. A., Rodnick, K. J., Henriksson, E. J., Youn, J. H., and Holloszy, J. O. (1992). Glucose transporters and maximal transport are increased in endurance-trained rat soleus. *J. Appl. Physiol.* **73**(2), 486–492.

FOR REFERENCE PURPOSES ONLY

Single-Embryo Measurement of Basal- and Insulin-Stimulated Glucose Uptake

Maggie M-Y. Chi and Kelle H. Moley

1. Introduction

Working with single-mouse embryos at the blastocyst stage is difficult from a biochemical standpoint because of the paucity of tissue. Each blastocyst contains only 25 ng of total protein (1) and has a volume of approx 160 pL (2,3). In order to measure glucose uptake, many groups have pooled embryos to increase the signal of radioactive 2-deoxyglucose transported into the blastocyst. The advantage of this technique is that single-embryo uptake can be measured using not radioactivity but enzymatic cycling reactions that are based on the amplification of a fluorescent signal. This signal is a pyridine nucleotide.

This technique was first described in 1935 by Negelein and Haas for determining glucose-6-phosphate dehydrogenase activity based on the increase in absorption in the near-ultraviolet (UV) as NADPH was produced (4). Greengard was the first to describe fluorometric pyridine nucleotide methods for measuring metabolites (5). Since that time, an extensive list of enzymes and metabolites has been measured with the aid of NAD and NADP (6). With the use of auxiliary enzymes, almost every substance of biological significance can be measured via a pyridine nucleotide system. Pyridine nucleotides have unusual properties that make them useful for analytic purposes (6). First, they act as natural oxidizing and reducing agents in many specific enzyme systems. Using the correct enzyme as a catalyst, selective oxidation or reduction of a substrate can be achieved in the presence of several other compounds. It is a rare substrate that cannot be linked by auxiliary reactions to one using NAD or NADP in this way. Second, the reduced form, NADH or NADPH, not only absorbs near-UV light but also is flu-

orescent, whereas the oxidized form is not. Moreover, this fluorescence can be measured accurately at concentrations as low as 10^{-7} M and this redox state or pyridine nucleotide can be measured with great sensitivity. Third, the reduced forms can be destroyed in acid, without affecting the oxidized forms, and the oxidized forms, can be destroyed entirely by alkali without affecting the reduced form. This means that at the end of a reaction the excess pyridine nucleotide of the reagent mix can be destroyed and only the generated product can be measured. Finally, two methods exist for measuring the pyridine nucleotides. Both the oxidized and reduced forms can be converted to highly fluorescent forms in strong alkali, allowing accurate measurements down to 10^{-8} M. In contrast, much greater sensitivity by orders of magnitude can be attained by enzymatic cycling in which the pyridine nucleotide acts as the catalytic intermediate for a two-enzyme system. This is the technique used to measure the femtomolar and picomolar quantities of metabolites in the individual blastocyst.

For measuring glucose uptake, 2-deoxyglucose (2-DG) is used as a tracer and the concentration of 2-DG transported into the blastocyst is measured. As described in detail in this chapter, 2-DG is linked to the production of NADPH by two reactions, and two further reactions are used to eliminate endogenous glucose and glucose-6-phosphate from the reaction measuring DG. These reactions generate NADPH, which is then cycled enzymatically. Finally, a byproduct of the cycling reaction is measured fluorometrically. These techniques have been used to measure glucose uptake in a wide variety of tissues, including preimplantation embryos (7–11).

2. Materials

2.1. Reagents

1. Pregnant mares serum gonadotropin (PMSG) and human chorionic gonadotropin (hCG) are used in superovulation (Sigma, St. Louis, MO). These should be made as solutions of 100 U/mL and stored in aliquots at -70°C . These gonadotropins lose their activity upon thawing and should be kept on ice until just prior to use.
2. Human tubal fluid media (HTF) (Irvine Scientific, Irvine, CA) with the addition of D-glucose to make the final concentration 5.6 mM and bovine serum albumin (BSA) (Sigma, fraction V) to make the final concentration of 0.25% are used to culture the embryos. These media are distributed by the company with expiration dates and can be kept at 4°C until that time.
3. B6X SJL F_1 female mice 3–4 wk of age (Jackson Laboratories, Bar Harbor, ME).
4. B6X SJL F_1 female mice 3–4 wk of age (Jackson Laboratories) are used to obtain the embryos (*see Note 1*).
5. Isopentane (Sigma) kept below boiling point with liquid-nitrogen bath.
6. Enzymes: Glucose-6-phosphate dehydrogenase (from *Leuconostoc mesenteroides*) (G6PDH) (Calbiochem, CA); beef liver glutamate dehydrogenase (GDH) (Roche);

phosphoglucoseisomerase (Roche); phosphofructokinase (Sigma); pyruvate kinase (Roche); 6-phosphogluconate dehydrogenase (Roche).

7. Ringers: Simple salt solution containing no glucose and 125 mM NaCl, 4.7 mM KCl, 2.5 mM CaCl₂, 2.4 mM MgSO₄, 1.2 mM K₂HPO₄, 25 mM NaHCO₃, 1% BSA radioimmunoassay (RIA) grade, fraction V (Sigma).
8. 2X 6-Phosphate removal reagent: 60 mM Tris-acetate (pH 8.1), 0.04% BSA, 6 mM MgCl₂, 100 μM NADP⁺, and 100 μg/mL glucose-6-phosphate dehydrogenase (G-6-PDH).
9. 4X Removal reagent: 50 mM Tris-acetate (pH 8.1), 0.04% BSA, 200 mM potassium acetate, 1.2 mM ATP, 4 mM phosphoenolpyruvate, 40 μg/mL phosphoglucoseisomerase, 65 μg/mL phosphofructokinase, 20 μg/mL pyruvate kinase, 40 μg/mL hexokinase.
10. 5X DG6P reagent: 50 mM Tris-acetate (pH 8.1), 0.04% BSA, 10 mM MgCl₂, 20 μM NADP⁺, 250 μg/mL G6PDH.
11. Imidazole buffer: 100 mM imidazole HCl (pH 7.0), 7.5 mM α-ketoglutarate (pH 7.0), 5 mM glucose-6-phosphate, 25 mM NH₄Ac, 0.02% BSA, 100 μM ADP.
12. 6-Phosphogluconate reagent: 50 mM imidazole HAc (pH 7.0), 1 mM EDTA, 30 mM NH₄Ac, 5 mM MgCl₂, 100 μM NADP⁺, and 2 μg/mL yeast 6-phosphogluconate dehydrogenase.
13. Insulin.
14. 0.16 M Tris-HCl (pH 8.1).
15. 0.12 N HCl
16. 0.3 and 1 N NaOH.

2.2. Equipment

1. Falcon organ culture dish, 1 mL; Falcon tissue culture supplies. This dish has an inner well holding 1 mL of solution and an outer well that can be filled with media to facilitate maintenance of adequate humidity.
2. 30-gauge Becton Dickinson needles attached to 1-mL syringes. This size is optimal for flushing embryos from the uterine horns.
3. Micropipet glass capillary, 100-μL volume pulled by heat to a fine point. The tip is broken off using a diamond-tipped pencil.
4. Braking pipet and loading tools, made by hand as described in **ref. 6**.
5. Vacuum drying tube (cat no. 6699-10; Ace Glass Inc., Vineland, NJ). The individual slides are stored back to back in a wooden slide holder containing a total of six slides.
6. Dissecting microscope with magnification of 0.5× or 1× objective with 10× oculars.
7. Teflon or polyethylene block; 25 × 120 × 5 mm drilled with 60 holes of 3-mm diameter used as an oil well.
8. Oil well oil: 30% Hexadecane and 70% USP light mineral oil. This mixture gives the correct viscosity to protect the added fluid droplet from access to CO₂ from air and still allow the droplet to fall rapidly to the bottom of the well when delivered from the constriction pipet. To ensure that the oil is free of disturbing impurities,

the oil mixture is washed 3 times by shaking vigorously in a separatory funnel with 1 volume of 0.5 M NaOH. The oil phase is removed and washed, and 0.01 M HCl and six changes of water until the washings are neutral. The oil is finally centrifuged at 10,000 rpm and the oil phase removed from the water phase. The last traces of water are removed by drying the oil in a vacuum desiccator.

9. Freeze-dryer attached to -35°C freezer with connectors for vacuum tubes.
10. Borosilicate glass fluorometer tubes, 10×75 mm.
11. Fluorimeter; a filter-type fluorimeter with a photomultiplier tube and continuously variable sensitivity from Optical Technology Devices (Elmsford, NY).
12. Constriction pipet (Bie and Berntsen Glass, Copenhagen, Denmark). These fine-tipped pipets should be made of quartz and bent at an angle of 45° so that it is possible to pipet into the oil with the hand steadied by resting on the working surface.

3. Methods

3.1. Recovery and Culturing of Embryos

1. B6 X SJL F1 female mice 3–4 wk of age are used, kept on a 12/12-h light–dark cycle, and given free access to food and water. Superovulation is achieved with an intraperitoneal injection of 10 IU per animal of PMSG followed 48 h later by 5 IU per animal of hCG. Female mice are mated with males of proven fertility overnight after hCG injection. Mating is confirmed by identification of a vaginal plug. Animals are then killed by cervical dislocation at 96 h after hCG administration and mating.
2. The uterine horns with ostia intact are dissected free and placed in HTF media that has been equilibrated overnight at 37°C in an atmosphere of 5% CO_2 /95% air. Preimplantation embryos are flushed immediately from the horns with a dissecting microscope by introducing a 30-gauge needle at the tubal ostia and flushing out the embryos into the HTF media.
3. The embryos that have progressed to a blastocyst stage are removed by mouth pipet using a pulled glass capillary tube and placed in a 1-mL organ culture dish containing HTF media.

3.2. 2-Deoxyglucose Uptake Assay

1. Blastocysts are moved by mouth pipet to HTF media supplemented with D-glucose to give a final concentration of 5.6 mM and containing 500 nM insulin for 30 min. Following this preincubation, they are moved in groups of 10–20 into Ringers wash and then into media containing 200 μM 2-DG for 15 min. A basal group is placed in HTF with 5.6 mM D-glucose with no insulin added.
2. The embryos are then removed, washed in DG-free, BSA-free Ringers solution for 1 min, and then transferred with 0.5–1 μL of the same salt solution onto a glass slide with a braking pipet. The embryo is then quick-frozen immediately by dipping the glass slide into isopentane brought to its freezing point (-170°C) with liquid N_2 .
3. The specimens are then freeze-dried on the slide at -35°C in a glass vacuum tube at a vapor pressure of <0.01 mm Hg. The slides are then stored at -20°C under reduced pressure.

3.3. Embryo Extraction

1. The freeze-dried embryo is transferred with a specially shaped hair point instrument into a droplet of the extraction reagent placed in wells 5 mm deep by 3 mm wide drilled in a piece of Teflon and covered with a layer of 70:30 oil. This droplet is 0.4 μL of a weak acid (0.02 N HCl) and the embryos are left in this solution for 20 minutes at room temperature. After this period of time, the extract is heated to 80°C for 20 min, destroying enzymes and preformed reduced pyridine nucleotides that may interfere with later measurements.
2. The extract is then returned to pH 8.1 by adding 0.1 μL of 0.16 M Tris base before proceeding with the assay. The final volume of this extraction mixture is 0.5 μL and these aliquots can be either assayed immediately or stored at -70°C in the oil well in a vacuum tube placed under reduced pressure to about one-fourth atmosphere.

3.4. 2-Deoxyglucose Assay Using Enzymatic Cycling in Oil Wells

The basic enzymatic cycling reaction involves three steps in order to measure deoxyglucose. In the first step, a 0.1- to 0.2- μL aliquot is removed from the neutralized acid extraction and used in the specific reaction sequence, ending in reduction of a pyridine nucleotide. This reaction sequence is found in **Fig. 1** and described in detail here. The second step is the enzymatic cycling or amplification step. NADPH is alternatively oxidized and reduced as seen in **Fig. 2**. In each oxidation/reduction cycle, 1 mol each of 6-phosphogluconate and glutamate is produced. A cycling rate of 150,000 cycles is achieved at room temperature overnight using 150 $\mu\text{g}/\text{mL}$ glutamate dehydrogenase and 15 $\mu\text{g}/\text{mL}$ G6PDH. After the desired multiple of amplification, the enzymes are inactivated in alkali with heat, and in the third step or the indicator step, the 6-phosphogluconate is measured by the fluorescence of the NADPH generated in the conversion of 6-phosphogluconate dehydrogenase. Each of these three steps will be described in detail.

1. The first step in the cycling reaction generates NADPH from deoxyglucose. This assay involves three steps, as seen in **Fig. 1**. First, in the oil well apparatus, a 0.1- μL aliquot of a 2X 6-phosphate removal reagent is added to 0.1 μL of extract. This addition converts all the 6-phosphate compounds [2-deoxyglucose-6-phosphate (DG-6-P) and glucose 6-phosphate (G-6-P)] to 6-phosphogluconates via an excess of the enzyme glucose-6-phosphate dehydrogenase (*L. mesenteroides*). This reaction occurs at room temperature over 40 min.
2. Following completion of the first reaction, 0.05 μL of 0.21 N HCl is added and the reaction mix heated to 80°C for 20 min to destroy the formed NADPH to avoid interference with subsequent steps. NaOH (0.21 N , 0.05 μL) is then added to neutralize the solution.
3. In the third step, 0.1 μL of a 4X removal reagent is added to the reaction and the reaction was allowed to occur over 20 min at room temperature. In this two-step reaction, hexokinase is added to convert the remaining free glucose and free DG to the

2-Deoxyglucose Assay

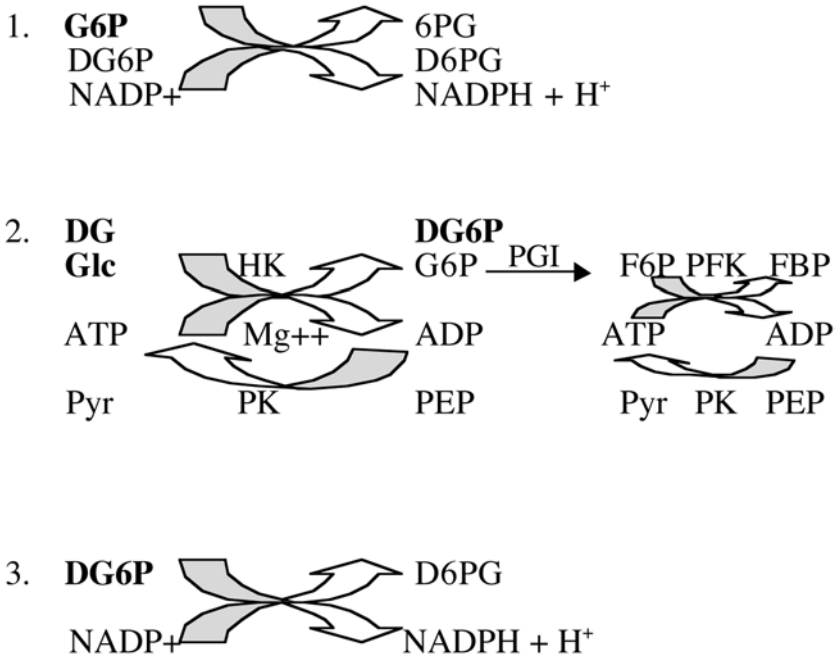

Fig.1. Description of the reactions used to measure 2-DG uptake.

6-phosphate compounds. Phosphoglucoseisomerase then selectively converts the formed G6P to fructose-6-P but does not convert DG6P. This phosphoglucoseisomerase reaction is then driven to completion by adding phosphofructokinase to convert the fructose-6-P to fructose-1,6-bisphosphate. ATP, pyruvate kinase, and phosphoenolpyruvate are added to drive both the phosphofructokinase and hexokinase reactions to completion by replenishing ATP levels. Following the 20 min at room temperature, the reaction is heated to 80°C for 20 min to destroy the enzymes and prevent the back reactions.

- In the next step, 0.1 μL of a 5X DG6P reagent is added to convert the remaining DG6P from the previous step, to deoxy-6-phosphogluconate, generating an equimolar amount of NADPH. This reaction is performed at room temperature for 40 min. In the final step, 0.1 μL of 0.3 *N* NaOH is added and the reaction is heated to 80°C for 20 min to destroy the enzymes and the excess NADP⁺.
- The NADPH generated in the final enzymatic reaction is then enzymatically amplified in the second step and the principle of these reactions is illustrated in **Fig. 2**. NADPH is alternatively oxidized by glutamate dehydrogenase (GDH) and reduced by G6PDH. In each cycle, 1 mol of 6-phosphogluconate and glutamate is produced.

Cycling Reaction:**Indicator Reaction:**

Fig. 2. Depiction of the cycling and indicator reaction used to measure 2-DG uptake in single embryos.

Cycling rates of 150,000 cycles are achieved using 150 $\mu\text{g}/\text{mL}$ GDH and 15 $\mu\text{g}/\text{mL}$ G6PDH at room temperature overnight. A 10- μL aliquot of the cycling reagent is added to the 0.6- μL reaction from the DG assay. This reagent consists of imidazole buffer with 150 $\mu\text{g}/\text{mL}$ beef liver glutamate dehydrogenase (GDH) and 15 $\mu\text{g}/\text{mL}$ *Leuconostoc* G6PDH added at room temperature overnight to give a cycling rate of 150,000 cycles. The reaction is stopped by adding 1 μL of 1 *N* NaOH and heating to 80°C for 30 min (see **Notes 2** and **3**).

- The third and final step in the cycling reaction is the indicator reaction. In this reaction, one of the cycling reaction products, 6-phosphogluconate (6-P-gluconate), is measured by a simple fluorometric assay using 6-phosphogluconate dehydrogenase to convert the substrate to ribulose 5-phosphate, CO_2 , and NADPH. A volume of 10 μL of the cycling reaction is added to 1 mL of the indicator, 6-phosphogluconate reagent. The fluorescence of the generated NADPH is measured directly in a 1-mL volume in $10 \times 75\text{-mm}$ fluorimeter tubes by use of a Farrand fluorimeter (see **Notes 4** and **5**).

4. Notes

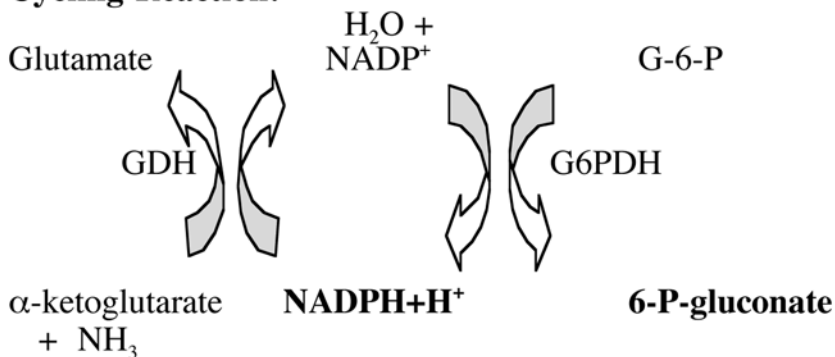
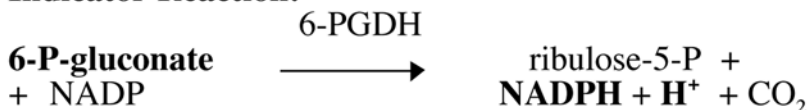
- This strain responds well to superovulation with 30–40 embryos per animal under the most optimal conditions. Mice should be ordered at 3 wk of age but allowed to adjust to their surroundings for 4–5 d prior to superovulation.
- The heat plus alkali completely inactivates the G6PDH before the last step to avoid an upward drift in fluorescence.

3. All cycling reagent components except the imidazole HCl and the enzymes can be stored at 20-fold concentrated stock solution in 50 mM imidazole HCl (pH 7.0) for many weeks at -80°C . The most unstable component is α -ketoglutarate. The 100 mM imidazole HCl (pH 7.0) and the enzymes are added just before use, and the reagent is then kept on ice to minimize the reagent blank from any trace of NADP^{+} that may be present.
4. Calculations are based on internal standards and are therefore independent of variation in enzyme activities, temperature, or incubation times. Exact proportionality between readings and NADPH concentrations are kept far below the Michaelis constants for the enzymes.
5. Measurements are expressed as millimoles per kilogram wet weight, with the value of 160 ng or 160 pL per embryo used in the calculation. These values are the means reported by Lewis and Wright (2) and Barbehenn et al. (3) for mouse preimplantation embryos. To express the data as picomole per embryo, the values can be multiplied by 0.16.

References

1. Turner, K., Rogers, A. W., and Lenton, E. A. (1994) Effect of culture in vitro and organ culture on the dry mass of preimplantation mouse embryos. *Reprod. Fertil. Dev.* **6**, 229–234.
2. Lewis, H. and Wright, E. D. (1925) *Carnegie Contrib. Embryol.* **25**, 113–143.
3. Barbehenn, E. K., Wales, R. G., and Lowry, O. H. (1978) Measurement of metabolites in single preimplantation embryos; a new means to study metabolic control in early embryos. *J. Embryol. Exp. Morphol.* **43**, 29–46.
4. Negelein, E. H. and Hass, E. (1935) *Biochem. Z.* **282**, 206–220.
5. Greengard, P. (1956) *Nature* **178**, 632–643.
6. Passonneau, J. V. and Lowry, O. H. (1993) *Enzymatic Analysis*, Humana, Totowa, NJ.
7. Chi, M. M.-Y., Manchester, J. K., Carter, J. G.; Pusateri, M. E., McDougal, D. B., and Lowry, O. H. (1993) A refinement of the Akabayashi–Saito–Kato modification of the enzymatic methods for 2-deoxyglucose and 2-deoxyglucose 6-phosphate. *Anal. Biochem.* **209**, 335–338.
8. Chi, M. M., Manchester, J. K., Basuray, R., Mahendra, S., Strickler, R. C., McDougal, D. B., Jr., et al. (1993) An unusual active hexose transport system in human and mouse preimplantation embryos. *Proc. Natl. Acad. Sci. USA* **90**, 10,023–10,025.
9. Chi, M. M., Schlein, A. L., and Moley, K. H. (2000) High insulin-like growth factor 1 (IGF-1) and insulin concentrations trigger apoptosis in the mouse blastocyst via down-regulation of the IGF-1 receptor. *Endocrinology* **141**, 4784–4792.
10. Chi, M. M., Pingsterhaus, J., Carayannopoulos, M., and Moley, K. H. (2000) Decreased glucose transporter expression triggers BAX-dependent apoptosis in the murine blastocyst. *J. Biol. Chem.* **275**, 40,252–40,257.
11. Moley, K. H., Chi, M., and Mueckler, M. (1998) Maternal hyperglycemia alters glucose transport and utilization in mouse preimplantation embryos. *Am. J. Physiol.* **275**, E38–E47.

Immunohistologic Staining of Muscle and Embryos to Detect Insulin-Stimulated Translocation of Glucose Transporters

Mary O. Carayannopoulos and Kelle H. Moley

1. Introduction

The facilitative glucose transporters constitute a family of integral membrane proteins, each with different substrate specificities, tissue distribution, and transport kinetics. It is possible to localize and track movement of facilitative glucose transporters within a cell using several different techniques: subcellular fractionation (1,2), surface labeling with the bis-mannose photolabel or Holman's reagent (3-5), immunoelectron microscopy (6,7), immunohistological techniques using confocal microscopy (8,9), and confocal microscopy studies using a fusion protein between green fluorescent protein (GFP) and any of the glucose transporters (10,11). These different localization techniques can be used in combination with uptake assays or by themselves to confirm translocation of the transporter to a plasma membrane location upon exposure to insulin or insulinlike growth factor-I (IGF-1). Immunohistochemical techniques have the advantage of localization within an intact cell, thus allowing confirmation of normal cell morphology in the cell subjected to insulin stimulation. This direct confirmation is important given that translocation can occur under several non-insulin-related events, such as starvation, temperature change, muscle contraction, or other stresses that the cell may undergo. These stresses can be identified by visualization, whereas other biochemical techniques would not give any indication of the overall status of the cell.

GLUT-4 and GLUT-8 are two facilitative glucose transporters that reside primarily in intracellular compartments and move to the plasma membrane upon exposure of particular cell types to insulin or IGF-1. GLUT-4 is found in

adipocytes, skeletal muscle, and cardiac muscle. GLUT-8 is found at highest levels in the preimplantation blastocyst. Insulin-stimulated glucose uptake is experienced by all these cell types and can be attributed in large part to translocation of these transporters to the plasma membrane (12,13). The following techniques outline the immunohistological methods used to visualize this translocation step.

2. Materials

2.1. Reagents

1. Pregnant mare serum gonadotropin (PMSG) and human chorionic gonadotropin (hCG) are used in superovulation (Sigma, St. Louis, MO). These should be made as solutions of 100 U/mL and stored in aliquots at -70°C (see **Note 1**).
2. Human tubal fluid media (HTF) (Irvine Scientific, Irvine, CA) with the addition of D-glucose to make the final concentration 5.6 mM and bovine serum albumin (BSA) (Sigma, fraction V, radioimmunoassay [RIA] grade) to make the final concentration 0.25% is used to culture the embryos. These media are distributed by the company with expiration dates and can be kept at 4°C until that time.
3. B6X SJL F₁ female mice of 3–4 wk of age (Jackson Laboratories, Bar Harbor, ME) are used to obtain the embryos (see **Note 2**).
4. Bovine pancreas insulin (Sigma) is diluted in 0.02 N HCl and used in the embryo studies. Purified porcine insulin (Iletin II; Lilly, IN) is used in the muscle studies.
5. Isotonic saline (phosphate-buffered saline [PBS]) alone or with 2% BSA added is used for washing the embryos (PBS-BSA).
6. Paraformaldehyde is used at a concentration of 3% in serum-free PBS for the embryo fixation and 4% for the muscle fixation step. For permeabilization, 0.01% Tween in serum-free PBS is used with the embryos and 0.1% Triton X-100 is used for muscle sections (see **Note 3**).
7. Donkey serum (Jackson Immuno Research Laboratory, PA) made as 100% is used for blocking and is stored at -70°C in aliquots. Rabbit anti-mouse GLUT-4 antibody is used as a primary antibody and fluorescein isothiocyanate (FITC) or other fluorescent moiety conjugated goat anti-rabbit serves as a secondary antibody. Both are diluted in PBS-BSA after centrifuging the original stocks for 2 min in the cold to pellet complexes and remove the supernatant.
8. TOPRO-3 is used as a nuclear dye (Molecular Probes, Eugene, OR) and is diluted in PBS to a final concentration of 4 μM . The stock solutions of 1 mM are stored at -20°C . The dye appears as a blue stain, with an absorbance wavelength of 625 nm and an emission wavelength of 660 nm.
9. Vectashield mounting solution (Vector Laboratories, CA) is used as an antibleaching mount.

2.2. Equipment

1. Falcon organ culture dish, 1 mL; Falcon tissue culture supplies. This dish has an inner well holding 1 mL of solution and an outer well that can be filled with media to facilitate maintenance of adequate humidity.

2. 30-gauge Becton Dickinson needles attached to 1-mL syringes are used to flush the uterine horns to obtain blastocysts.
3. Micropipet glass capillary tubes, 100 μ L volume, are pulled by heat to a fine point and used for mouth pipetting. The tips are scored with a diamond pencil and broken off sharply.
4. Superfrost plus glass slides (Fisher) are used to mount all tissue. These specially treated slides allow the tissue to electrostatically adhere to the slides.
6. A Leica cryostat is used to make the frozen sections. The muscle tissue is mounted in M-1 embedding matrix (Lipshaw, PA) and placed at -70°C .
7. An MRC-600 confocal microscope is used to image the slides (Bio-Rad Laboratories, CA). The magnification used is $60\times$ with oil, and a zoom mode can be used, although the resolution may not be as clear.
8. Humidified chamber. This can be made from any container, such as a pipet tip box, by adding a moistened towel to the bottom of a container. The slides should be elevated off the towel and a lid can be loosely attached.
9. A PAP pen (Daido Sangyo, Co. Japan) is used to make a well that surrounds the tissue to be examined.
10. Dissecting microscope with magnification of $0.5\times$ or $1\times$ objective with $10\times$ oculars. A lighted base is necessary for optimal viewing of the embryos.

3. Methods

3.1. Embryo Preparation

1. B6 X SJL F1 female mice 3–4 wk of age are used, kept on a 12/12-h light–dark cycle and given free access to food and water. Superovulation is achieved with an intraperitoneal injection of 10 IU per animal of PMSG followed 48 h later by 5 IU per animal of hCG. Female mice are mated with males of proven fertility overnight after hCG injection. Mating is confirmed by identification of a vaginal plug. Animals are then killed by cervical dislocation at 96 h after hCG administration and mating.
2. The uterine horns with ostia intact are dissected free and placed in HTF/0.25%BSA media that has been equilibrated overnight at 37°C in an atmosphere of 5% CO_2 /95% air. Preimplantation embryos are flushed immediately from the horns with a dissecting microscope by introducing a 30-gauge needle at the tubal ostia and flushing out the embryos into the HTF/0.25%BSA media.
3. The embryos that have progressed to a blastocyst stage are removed by mouth pipet using a pulled glass capillary tube and placed in a 1-mL organ culture dish containing HTF media.

3.2. Embryo Fixation

1. Following the incubation, the embryos are moved immediately by mouth pipet to a droplet of 3% paraformaldehyde for 30 min. These droplets are placed in a culture dish.
2. After this time, they are moved to a droplet containing 0.01% Tween-20 in PBS for 10 min, again transferred to a Petri dish. Finally, the embryos are moved to a Super-

frost slide in a minimal amount of fluid. The transferred fluid is then removed, leaving the embryos to dry.

3. A PAP pen is then used to draw a circle around the embryos to create a well. The embryos can be stored fixed on the slide at -20°C for approx 2–3 mos (*see Note 4*).

3.3. Embryo Immunoblotting

All further steps of the immunoblotting and washing are done at room temperature by adding solutions as droplets to the well created by the PAP pen and removing them by mouth pipetting under direct visualization with the dissecting microscope. This is done to avoid aspiration of the embryos, which do not always adhere permanently to the glass.

1. The embryos are blocked with PBS containing 20% donkey serum and 2% BSA for 1 h by adding a droplet of the blocking solution to the well on the slide.
2. Following the incubation, the embryos are washed three times with the PBS–2% BSA solution, 10 min for each wash. After this wash, the embryos are incubated in 20 $\mu\text{g}/\text{mL}$ of peptide-purified rabbit anti-mouse GLUT-8 in the PBS–2% BSA solution and all further steps are done in the dark. This primary antibody is left on the embryos for 30 min, after which the embryos again are washed with the PBS–2% BSA solution three times for 10 min each wash.
3. Following the wash, the secondary antibody, a FITC-labeled goat anti-rabbit antibody is added at a concentration of 1 : 80 for an additional 30 min. Following the three washes at 10 min each of PBS-BSA, the nuclear stain, TOPRO-3, is added at a concentration of 4 μM in PBS. This stain is left in place for 20 min. Again, the embryos are washed as described previously for the other incubations.
4. Following the final wash, all fluid is removed from the droplet, leaving the embryos to dry on the slide. A small droplet of Vectashield is placed on a cover slip, which is then placed over the well. The cover slip is sealed with clear nail polish and viewed under confocal microscopy (*see Note 5*).

3.4. Muscle Preparation

1. Male B6 X SJL F1 mice are allowed free access to food and water and kept on a 12/12-h light–dark cycle. The mice are then given an intraperitoneal injection of glucose (2 g/kg of body weight) and either insulin (6 U) or saline.
2. Over the next 30 min, the mice are anesthetized with pentobarbital (5 mg/100 g of body weight), and a butterfly needle connected to iv tubing is introduced in the dorsal tail vein of the animal. At exactly 30 min after the insulin or saline injection, 5% paraformaldehyde is injected into the tail vein and the animal is observed for whole-body fixation.
3. Immediately the hindlimb leg muscles are dissected for isolation of the soleus and dorsal tibialis muscles. Submerging the entire muscle in liquid nitrogen quickly freezes these fixed muscles.

4. An alternative method of muscle preparation is to anesthetize the mouse first and remove the right soleus or dorsal tibialis muscle for a basal state. This muscle is then fixed by incubation in 3% paraformaldehyde in PBS for 2 h. The mouse is then given glucose (2 g/kg of body weight) and insulin (6 U) by intraperitoneal injection. After 30 min, the remaining muscle of the pair is dissected and fixed as described in the preceding steps (see **Note 6**).
5. The frozen fixed or fixed muscle is then mounted on a cryostat holder with M-1 embedding matrix and cooled to -70°C . Frozen sections are cut with the cryostat at a thickness of 7–10 μm and placed on Superfrost plus slides. The slides are stored at -70°C .

3.5. Muscle Immunoblotting

1. Again, the PAP pen is used to draw a circle around the sections in order to create a well. The cells are permeabilized by adding a droplet of 0.1% Triton X-100 in PBS for 15 min and then washed by mouth pipet three times in PBS-BSA droplets for 10 min each.
2. The slides are then blocked with PBS-BSA containing 20% donkey serum for 1 h. After washing in the same fashion, a drop containing 20 $\mu\text{g}/\text{mL}$ of polyclonal rabbit anti-mouse GLUT-4 antibody is added to the cells. This antibody is affinity purified on a protein-A column. This solution is left in place for either 1 h at room temperature or overnight at 4°C in a humidified chamber.
3. Following the primary antibody incubation, the slides are washed as described previously and the secondary antibody, FITC-labeled goat anti-rabbit, is added as a droplet to the cells at a concentration of 1 : 80.
4. Following three 10-min washes, the nuclear stain, TOPRO-3 in PBS at 4 μM , is added for 20 min. After careful washing, a drop of Vectashield is added to the slide and a cover slip placed and sealed with nail polish. The slides are then viewed by confocal microscopy.

4. Notes

1. These gonadotropins lose their activity upon thawing and should be kept on ice until just prior to use.
2. This strain responds well to superovulation with 30–40 embryos per animal under the most optimal conditions. Mice should be ordered at 3 wk of age but allowed to adjust to their surroundings for 4–5 d prior to superovulation..
3. Care should be taken to keep the pH of the fixative between 6.0 and 7.0.
4. It is important to transfer the embryos in the smallest possible volume to avoid diluting prior conditions. It is also necessary to follow the time periods suggested for fixation and permeabilization, as longer times will allow the embryos to firmly adhere to the plastic and forceful removal may cause destruction of the embryos.
5. Care should be taken in mounting the embryos. A small droplet, 4–5 μL , of Vectashield is added to the cover slip, and the coverslip is inverted with the droplet directly over the PAP well. Too much Vectashield will cause the embryo to float out and over the well if it is not firmly adherent. Too little mounting solution will cause

bleaching to occur and may cause visualization to be impossible. Often it is helpful to redraw the encircling PAP pen well just prior to the placement of the cover slip to avoid losing the embryos.

6. This technique allows the mouse to serve as its own control and is somewhat easier than the whole-animal fixation technique. The problem with this alternative method, however, is that the muscle dissection occurs before fixation, and if the muscle contracts during this dissection, translocation may occur regardless of insulin stimulation. This contraction-induced translocation may inadvertently drive the GLUT-4 to the plasma membrane and thus interfere with detection of a difference in location between the transporter in a basal versus insulin-stimulated state.

References

1. Herman, G. A., Bonzelius, F., Cieutat, A. M., and Kelly, R. B. (1994) A distinct class of intracellular storage vesicles, identified by expression of the glucose transporter GLUT-4. *Proc. Natl. Acad. Sci. USA* **91**, 12,750–12,754.
2. Hresko, R. C., Heimberg, H., Chi, M. M., and Mueckler, M. (1998) Glucosamine-induced insulin resistance in 3T3-L1 adipocytes is caused by depletion of intracellular ATP. *J. Biol. Chem.* **273**, 20,658–20,668.
3. Ryder, J. W., Yang, J., Galuska, D., et al. (2000) Use of a novel impermeable biotinylated photolabeling reagent to assess insulin- and hypoxia-stimulated cell surface GLUT-4 content in skeletal muscle from type 2 diabetic patients. *Diabetes* **49**, 647–654.
4. Satoh, S., Nishimura, H., Clark, A. E., et al. (1993) Use of bismannose photolabel to elucidate insulin-regulated GLUT-4 subcellular trafficking kinetics in rat adipose cells. Evidence that exocytosis is a critical site of hormone action. *J. Biol. Chem.* **268**, 17,820–17,829.
5. Hansen, P. A., Wang, W., Marshall, B. A., Holloszy, J. O., and Mueckler, M. (1998) Dissociation of GLUT-4 translocation and insulin-stimulated glucose transport in transgenic mice overexpressing GLUT1 in skeletal muscle. *J. Biol. Chem.* **273**, 18,173–18,179.
6. Wang, W., Hansen, P. A., Marshall, B. A., Holloszy, J. O., and Mueckler, M. (1996) Insulin unmasks a COOH-terminal GLUT-4 epitope and increases glucose transport across T-tubules in skeletal muscle. *J. Cell. Biol.* **135**, 415–430.
7. Malide, D., Ramm, G., Cushman, S. W., and Slot, J. W. (2000) Immunoelectron microscopic evidence that GLUT-4 translocation explains the stimulation of glucose transport in isolated rat white adipose cells. *J. Cell. Sci.* **113**, 4203–4210.
8. Moley, K. H., Chi, M., and Mueckler, M. (1998) Maternal hyperglycemia alters glucose transport and utilization in mouse preimplantation embryos. *Am. J. Physiol.* **275**, E38–E47.
9. Pinto, A., Carayannopoulos, M., Hoehn, A., Dowd, L., and Moley, K. (2002) Glucose transporter 8 expression and translocation are critical for murine blastocyst survival. *Biol. Reprod.* **66**, 1729–1733.
10. Thurmond, D. C., Ceresa, B. P., Okada, S., Elmendorf, J. S., Coker, K., and Pessin, J. E. (1998) Regulation of insulin-stimulated GLUT4 translocation by Munc18c in 3T3L1 adipocytes. *J. Biol. Chem.* **273**, 33876–33883.

11. Thurmond, D. C., Kanzaki, M., Khan, A. H., and Pessin, J. E. (2000) Munc18c function is required for insulin-stimulated plasma membrane fusion of GLUT-4 and insulin-responsive amino peptidase storage vesicles. *Mol. Cell. Biol.* **20**, 379–388.
12. Wilson, C. M. and Cushman, S. W. (1994) Insulin stimulation of glucose transport activity in rat skeletal muscle: increase in cell surface GLUT-4 as assessed by photolabelling. *Biochem. J.* **299**, 755–759.
13. Carayannopoulos, M., Chi, M., Cui, Y., Pingsterhaus, J., and Moley, K. (2000) GLUT8 is a glucose transporter responsible for insulin-stimulated glucose uptake in the blastocyst. *Proc. Natl. Acad. Sci. USA* **97**, 7313–7318.

FOR REFERENCE PURPOSES ONLY